

Operating Instructions

Swing Door MPS-122

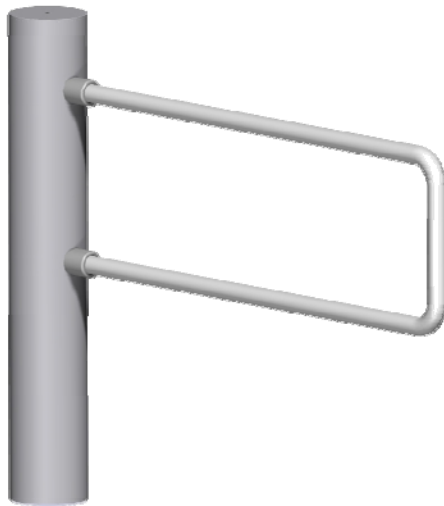

Translation of the original operating instructions

MAGNETIC Autocontrol GmbH
Grienmatt 20
79650 Schopfheim
Germany

Tel.: +49 (0) 7622 695 5
Fax.: +49 (0)7622 695 602
E-Mail: info@ac-magnetic.com
Internet: www.ac-magnetic.com

Contents

1	General	7
1.1	Information regarding the operating instructions	7
1.2	Pictogram explanation	8
1.3	Limitation of liability	9
1.4	Copyright protection.....	9
1.5	Scope of delivery	10
1.6	Spare parts	10
1.7	Warranty conditions	11
1.8	Customer service	11
1.9	Conformity declaration.....	11
1.10	Environmental protection	11
2	Safety	12
2.1	Intended use	12
2.2	Changes and modifications	12
2.3	Operating personnel	13
2.3.1	Requirements	13
2.4	Personal protective equipment	14
2.5	Occupational safety and special dangers	14
3	Technical data	18
3.1	Electrical connection	18
3.2	Operating conditions	18
3.3	Weight.....	18
3.4	Performance data	18
4	Design and function	19
4.1	Design.....	19
4.2	Designs	20
4.3	Function	20
5	Assembly and installation	21
5.1	Safety.....	21
5.2	Requirements for assembly	22
5.3	Foundation and empty conduits.....	23
5.3.1	Foundation plan.....	24
5.4	Mounting the swing door MPS-122	25
5.4.1	Mounting the swing door on the foundation	26
5.4.2	Disassemble swing door	27

Contents

6	Electrical connection	30
6.1	Safety	30
6.2	Supply voltage connection	32
6.2.1	Connecting the supply voltage	32
6.2.2	Connect control lines to MBC-111	32
7	Assemble MPS column	33
7.1.1	Setting the two mechanical end stops	34
8	Commissioning	35
8.1	Safety	35
8.2	Commissioning	36
9	Function description MBC 111	37
9.1	Digital inputs	37
9.1.1	Technical data for the inputs	37
9.1.2	Function of digital inputs	37
9.2	Relay outputs	38
9.2.1	Technical data for the outputs	38
9.2.2	Function of the outputs	38
9.3	Diagnosis display	39
9.3.1	Function of diagnosis display	39
9.3.2	CAN bus addressing and termination	40
10	Mode: MPS Standard	41
10.1	Power-off state	41
10.2	Start-up routine	41
10.3	Homing	41
10.4	Normal motion	42
10.5	Special cases within motion sequence	43
10.5.1	Obstacle recognition during motion	43
10.5.2	Turning back during motion	43
10.5.3	Attempted vandalism	43
10.5.4	Emergency	43

11	MPS-Diag programme	44
11.1	Connect laptop to control device MB-111.....	45
11.2	Using the MPS-Diag programme.....	45
11.3	Function and Parameter Settings.....	46
11.3.1	Design left / right	46
11.3.2	Brake activated / not activated	47
11.3.3	Selecting the locking bracket size	48
11.3.4	Select reset source.....	48
11.3.5	Behaviour when obstruction detected	48
11.3.6	Set hold-open time	49
11.3.7	Set speed	49
11.3.8	Heating active while standing.....	49
11.3.9	Teaching the three possible positions.....	50
11.3.10	Reset all parameters to factory settings.....	52
11.4	Firmware download	53
11.4.1	Firmware download using a ".mcp file"	55
11.4.2	Firmware download using an ".s file"	55
11.5	Download between MBC-111 and MMC-120	57
11.6	Reading errors	58
11.7	Status request.....	59
12	Maintenance	60
12.1	Safety	60
12.2	Cleaning	62
12.3	Maintenance schedule.....	63
13	Spare parts	64
14	Decommissioning and disposal.....	64
15	Conformity declaration.....	66
16	Appendix.....	67
16.1	Electric circuit diagram.....	67
	Index.....	68

1 General

1.1 Information regarding the operating instructions

These operating instructions provide important information on how to deal with the MAGNETIC swing door MPS-22. Prerequisite for safe working is the observance of all specified safety notes and instructions.

In addition, the local accident prevention regulations valid at the barrier's area of application and general safety regulations have to be complied with.

Carefully read the operating instructions before starting any work! They are a product component and must be kept well accessible to the personnel at all times.

When passing the barrier on to third parties, the operating instructions must also be handed over.

Components from other suppliers may have their own safety regulations and instructions for use. These must also be observed.

General

1.2 Pictogram explanation

Warning notes

Warning notes are characterised by pictograms in these operating instructions. The warning notes are precluded by signal words expressing the scale of the hazard.

It is absolutely essential to observe the notes and to proceed with caution in order to prevent accidents as well as bodily injuries and property damage.

! DANGER!



DANGER!

... indicates an immediately dangerous situation, which leads to death or severe injuries if it is not avoided.

! WARNING!



WARNING!

... indicates a potentially dangerous situation, which can lead to death or severe injuries if it is not avoided.

! CAUTION!



CAUTION!

... indicates a potentially dangerous situation that can lead to minor injuries if it is not avoided.

NOTICE!



NOTICE!

... indicates a potential dangerous situation that can lead to property damage if it is not avoided.

Hints and recommendations



NOTE!

... highlights useful hints and recommendations as well as information for an efficient and trouble-free operation.

1.3 Limitation of liability

All specifications and notes in these operating instructions were compiled with consideration to the valid standards and regulations, the state of the art as well as to our long-standing knowledge and experience.

The manufacturer is not liable for damage caused by:

- Non-observance of the operating instructions
- Improper use
- Deployment of non-trained personnel
- Arbitrary modifications
- Technical changes
- Use of non-approved spare and wear parts.

The actual scope of supply may differ from the explanations and illustrations described in this manual in case of special designs, if additional order options are made use of, or due to latest technical changes.

Incidentally, the responsibilities agreed upon in the delivery contract, the general terms and conditions as well as the manufacturer's conditions of delivery and the statutory provisions valid at the time of contract conclusion shall apply.

Warranty

The manufacturer guarantees the functionality of the products supplied and the established performance parameters.

The warranty period commences on the date the barrier module is delivered to the customer.

1.4 Copyright protection

Surrendering the operating instructions to third parties without written permission of the manufacturer is not permitted.



NOTE!

Content details, texts, drawings, pictures and other illustrations are protected by copyright and are subject to industrial property rights. Any improper use shall be liable to prosecution.

Any type and form of duplication – also of extracts – as well as the exploitation and/or communication of the contents are not permitted without the manufacturer's written declaration of consent.

General

1.5 Scope of delivery

The scope of delivery comprises:

- 1 x Swing doors with integrated drive and built-in MBC and MMC control devices
- 1 x Bracket or glass wing
- 1 x USB extension
- 1 x Fastening kit (only within Europe)

Supplied documentation:

- 1 x Operating instructions on flash drive / cd
- 1 x Electric circuit diagram

Optionally available:

- MPS-Diag Windows software for setting functions and parameters and for error diagnosis

1.6 Spare parts

 WARNING!	
	<p>WARNING! Risk of injury by incorrect spare parts! Incorrect or defective spare parts can result in damage, malfunctions or total failure and also impair safety. Therefore:</p> <ul style="list-style-type: none"> – Use only the manufacturer's original spare parts.

Procure spare parts from authorised dealers or directly from the manufacturer. Refer to Page 2 for address.

A list of spare parts can be obtained on request.

1.7 Warranty conditions

Subject to the condition that the operating instructions are observed, and that no inadmissible operations are carried out on the technical equipment, and that the installation has suffered no mechanical damage, MAGNETIC grants warranty for all mechanical and electrical components for the duration as stated in our standard terms of sales and delivery or as contractually agreed in writing.

1.8 Customer service

Our customer service can be contacted for any technical advice. Information about the responsible contact person can be retrieved by telephone, fax, email or via the Internet at any time, refer to manufacturer's address on Page 2.



NOTE!

In order to enable fast handling, note the data of the type plate such as type, serial number, version etc. before calling.

1.9 Conformity declaration

Conformity declaration (in accordance with EC Machine Directive 2006/42/EC) see page 66.

1.10 Environmental protection

NOTICE!	
	<p>NOTICE! Danger for the environment by hazardous materials!</p> <p>Incorrect handling of environmentally hazardous materials, in particular incorrect disposal, can substantially damage the environment.</p> <p>Therefore:</p> <ul style="list-style-type: none"> – Observe the valid environmental directives. – After appropriate disassembly, the parts have to be recycled. – Separate recyclable fraction and feed to recycling. – Take immediate suitable measures if environmentally hazardous materials are inadvertently released into the environment. In case of doubt, inform the responsible local authority about the damage.

2 Safety

2.1 Intended use

The MAGNETIC pedestrian barrier MPS is intended exclusively for managing the admission in to areas with restricted access.

In general, the swing door is integrated in the fence and gate systems.

The integrated MAGNETIC universal controller MBC and MMC are intended exclusively for controlling the MAGNETIC pedestrian barrier MPS.

! WARNING!	
	<p>WARNING! Non-intended use is dangerous!</p> <p>Any use of the barriers other than intended and/or in a different manner can cause hazardous situations.</p> <p>Therefore:</p> <ul style="list-style-type: none"> – Only use the pedestrian barrier and the controllers for the intended use. – All specifications in these operating instructions have to be strictly complied with.

Any types of claims due to damage arising from improper use are excluded. The operator alone shall be responsible for any damage arising from improper use.

2.2 Changes and modifications

Changes and modifications of the barrier modules can cause unforeseen danger.

A written authorisation of the manufacturer is absolutely required before executing any technical changes and modifications at the barrier modules, the control unit or the control program.

2.3 Operating personnel

2.3.1 Requirements

⚠ WARNING!	
	<p>WARNING! Risk of injury in case of inadequate qualification!</p> <p>Improper handling can lead to considerable bodily injuries and property damage.</p> <p>Therefore:</p> <ul style="list-style-type: none"> – Activities must only be carried out by the individuals designated for that purpose.

The operating instructions specify the following qualification requirements for the different fields of activity:

- **Instructed people**
 have been instructed during instructions provided by the operator with regard to the work assigned to them and possible hazards arising from improper conduct.
- **Specialised staff**
 is due to its technical training, knowledge and experience as well as due to its knowledge of the pertinent regulations able to carry out the work assigned to it and to independently recognise potential hazards.
- **Qualified electricians**
 are able, due to their technical training, knowledge and experiences as well as knowledge of the relevant standards and regulations, to execute tasks on electrical systems and to independently recognise possible hazards.
 In Germany, the qualified electrician must fulfil the provisions of the accident prevention regulation BGV A3 (e.g. master electrician). Appropriate regulations apply in other countries.
 The regulations valid there must be observed.

It must be expected that only those people are deployed who carry out their work reliably. People, whose ability to respond is affected, e.g. by drugs, alcohol or medicines, may not be assigned. Furthermore, the age and profession-specific regulations valid at the operating location must be observed when selecting personnel.

Safety

2.4 Personal protective equipment

It is necessary to wear personal protective equipment when dealing with the machine so as to minimise health hazards.

Before carrying out any work, properly put on the necessary protective equipment such as work clothes, protective gloves, safety shoes and wear during work.

2.5 Occupational safety and special dangers

The remaining risks resulting from the hazard analysis are specified in the following section.

Observe the safety notes listed here and the warning notes mentioned in the other chapters of these instructions to reduce health hazards and to avoid dangerous situations.

Danger pictograms on the pedestrian barrier MPS-122

The relevant dangerous areas on the barriers can be identified by the following pictograms:

Electric current

⚠ DANGER!	
	<p>DANGER! Mortal danger by electric current!</p> <p>... indicates life threatening situations caused by electric current. Non-observance of the safety instructions causes severe injuries or death. Necessary work may only be carried out by a qualified electrician.</p> <p>This pictogram is fixed on the following component:</p> <p>—</p>

Hazard notes and occupational safety

For your own safety and for the protections of the barrier modules, the following information must be observed and complied with:

Electric current

⚠ DANGER!	
	<p>DANGER! Mortal danger by electric current!</p> <p>Touching live parts can be lethal. Damage to the insulation or to individual components can be lethal.</p> <p>Therefore:</p> <ul style="list-style-type: none"> – Switch off the power supply immediately in case of damage to the insulation and arrange repair. – Only qualified electricians may carry out work on the electrical system. – Before starting work, ensure that the electrical system is powered down! – Always turn the power supply off and safeguard against unintentional restarting before maintenance, cleaning, and repair work. Never bypass or deactivate fuses. – Never bypass or deactivate fuses. – When replacing fuses observe the correct amperage specification. – Keep moisture away from live parts, this can result in short-circuit. <p>Safety devices:</p> <p>The following safety equipment has to be installed on site. The safety equipment is to be provided by the customer.</p> <ul style="list-style-type: none"> – Residual current device (RCD) – Residual current device (RCD) – Circuit-breaker

Safety

Improper transport

⚠ WARNING!	
	<p>WARNING! Danger by falling down or tilting of a pedestrian barrier!</p> <p>The weight of the pedestrian barrier or heavy parts of it can seriously injure a person and cause serious crushing!</p> <p>Therefore:</p> <ul style="list-style-type: none"> – Have all transport work performed by trained personnel. – Depending on the dead weight and size of the components, use a pallet on which the barrier module can be moved by means of a forklift. – For lifting a pedestrian barrier, use suitable lifting gear that is designed for the weight of the barrier. – Lifting and carrying the pedestrian barrier or heavy parts of it from the pallet should be done by a minimum of two people.



Heavy weight

⚠ WARNING!	
	<p>WARNING! Risk of injury when lifting heavy objects alone!</p> <p>The weight of heavy objects can severely injure a person!</p> <p>Therefore:</p> <ul style="list-style-type: none"> – Carrying the pedestrian barrier and heavy parts and lifting them from the pallet should be done by a minimum of two people.



Insufficient fixing

⚠ WARNING!	
	<p>WARNING! Risk of injury at insufficient fixing!</p> <p>Insufficient fastening of the barrier modules or any single component can severely injure a person and cause severe crushing!</p> <p>Therefore:</p> <ul style="list-style-type: none"> – Before operation ensure the firm attachment of the clamp bolts. – Check the firm fixing of all screws according to maintenance schedule. – Only qualified and skilled personnel are allowed to assemble the pedestrian barrier and the appropriate components.



Inadmissible operation

 WARNING!	
	<p>WARNING! Risk of injury at inadmissible operation!</p> <p>An inadmissible operation can cause death or severe injuries.</p> <p>Therefore:</p> <ul style="list-style-type: none">– Before operating the barriers check all electrical and mechanical functions.

Sharp edges and spiky corners

 WARNING!	
	<p>WARNING! Risk of injury on edges and corners!</p> <p>Sharp edges and spiky corners can cause skin abrasions and cuts.</p> <p>Therefore:</p> <ul style="list-style-type: none">– Work carefully near to sharp edges and spiky corners.– In case of doubt wear protective gloves.

Signposting

 WARNING!	
	<p>WARNING! Risk of injury by illegible symbols!</p> <p>Labels and signs can become dirty or unrecognisable in the course of time.</p> <p>Therefore:</p> <ul style="list-style-type: none">– Always keep safety, warning and operating notes in a well readable condition.– Immediately renew damaged or unrecognisable signs or labels.

Technical data

3 Technical data

3.1 Electrical connection

Designation	Unit	Value	
		MPS-122	
Supply voltage	[V AC / Hz]	110 to 240 / 50 /60	
		115 V	230 V
Current consumption: Pedestrian barrier closed	[A]	0,5	0,3
Current consumption: Barrier in motion	[A]	1,0	0,6
Starting current (approx. 30ms)	[A]	2,0	1,7
Power consumption: Off-position	[W]	45	45
Power consumption: Barrier in motion	[W]	75	75
Duty cycle	[%]	100	100
Control voltage	[V DC]	42 / 30	42 / 30

Table 1: Electrical connection

3.2 Operating conditions

Designation	Unit	Value	
		MPS-122	
Ambient temperature range	[°C]	-25 to +45	
Protection class	-	IP 44	

Table 2: Operating conditions

3.3 Weight

Designation	Unit	Value	
		MPS-122	
Weight	[kg]	40	

Table 3: Weight

3.4 Performance data

Designation	Unit	Value	
		MPS-122	
Runtime for 90°	[s]	adjustable from 1.5 to 4.0	

Table 4: Line data

4 Design and function

4.1 Design

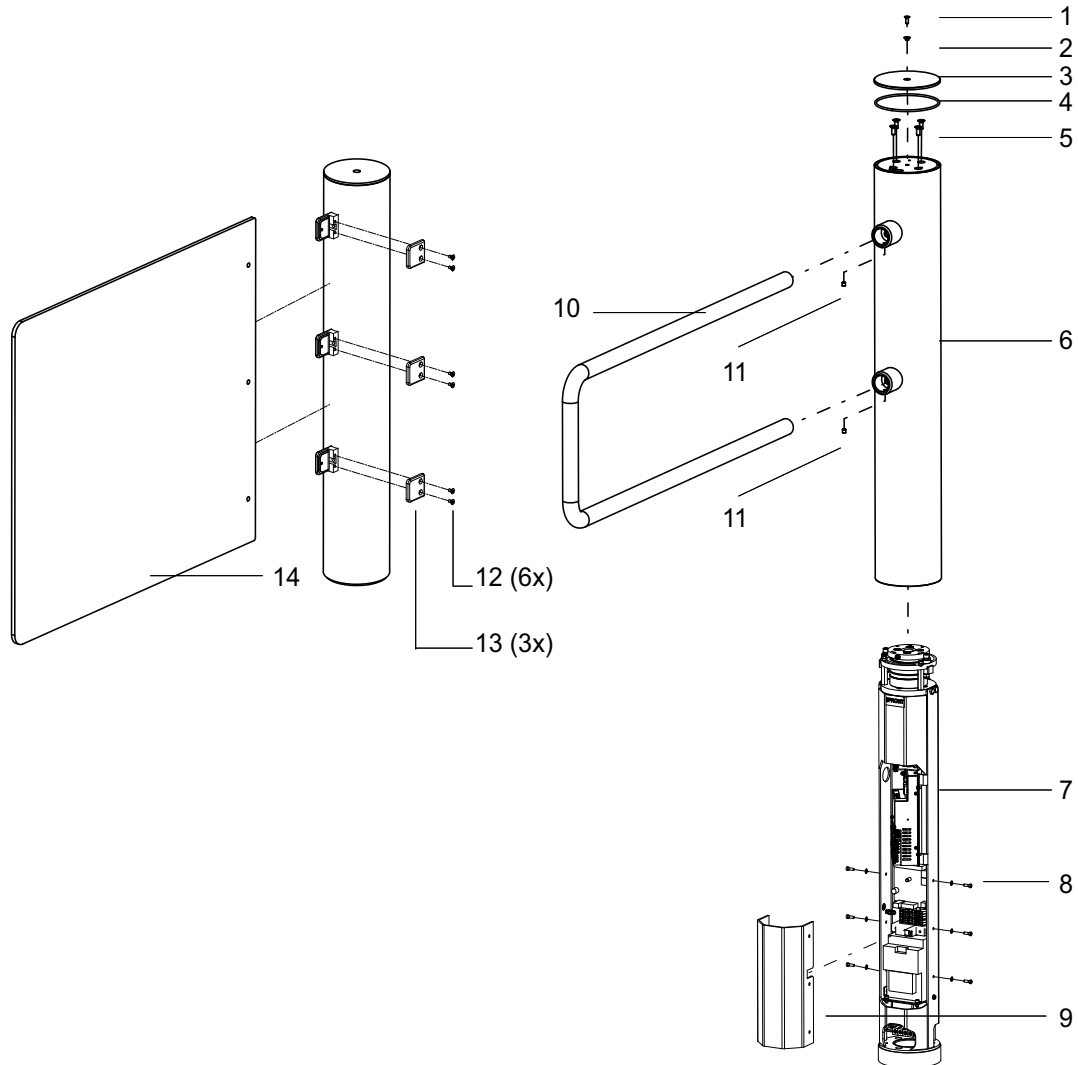

Fig. 1: Component Design

- | | | | |
|---|---|----|------------------------|
| 1 | Recessed head screw M6 x16 | 8 | Disc/screws M5 x 16 |
| 2 | Insulating bush | 9 | Reinforcement |
| 3 | Top cover disc | 10 | Bracket |
| 4 | O ring | 11 | Threaded pin |
| 5 | Recessed head screws M8 x 20 | 12 | Recessed head screw M6 |
| 6 | Outer tube | 13 | Glass holder |
| 7 | Edge profile
(with drive, steering device and transformer) | 14 | Glass wings |

Design and function

4.2 Designs

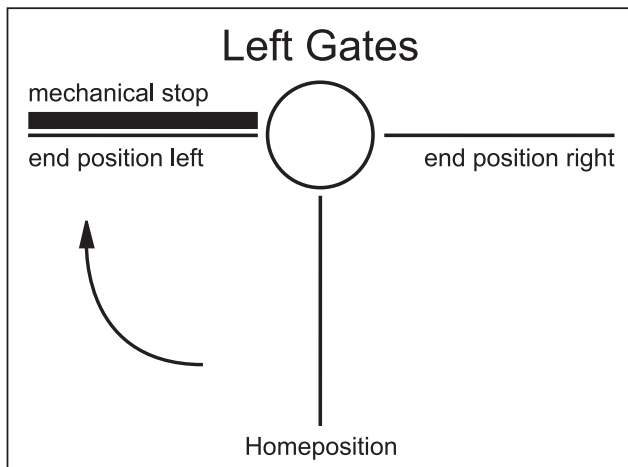

Fig. 2: Design "left"

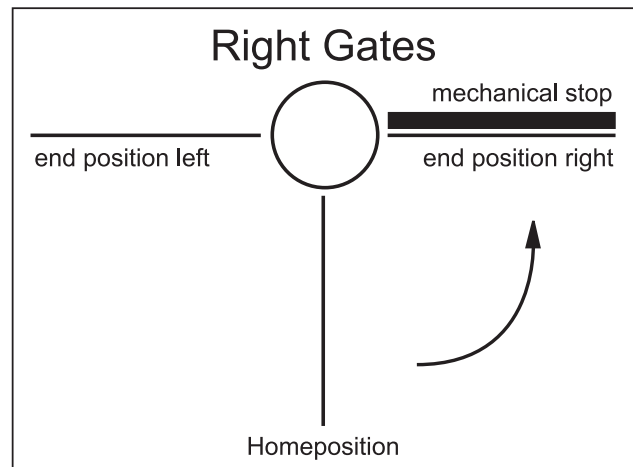

Fig. 3: Design "right"

4.3 Function

The swing door MPS is a pedestrian barrier to control access of persons in simple security applications, usually under supervision. It is also used to complement our turnstiles and wing barriers, in particular for areas into which bulky objects must be taken or where access control must include persons in wheelchairs.

The swing door can be used in both directions. Ex works, the swing door is configured for bidirectional operation with an opening angle of $2 \times 90^\circ$. The opening angles can be adjusted between 10° and 300° using PC software. Further parameters, such as speed, hold-open time, etc. can be adjusted with the software.

The swing door is opened by external access control systems and digital inputs. It is closed fully automatically after the end of the set hold-open time.

The drive system, consisting of our MHTM® (Magnetic High Torque Motor) in connection with a planetary drive ensures powerful and precise motion. On demand, the swing door can be locked in the three end positions using an electro-mechanical tooth coupling.

If the bracket is pressed from the lock forcefully, it is not damaged. After forceful entrance, the bracket automatically falls back into its initial position.

The complete drive is nearly maintenance- and wear-free and works without a limit switch.



In case of a power outage, the swing door can be freely turned into either direction.

The casing consists of a polished V2A stainless steel cylinder with a diameter of 159 mm. The swing door is mounted on the complete floor plate using 3 M8 screws.



5 Assembly and installation

5.1 Safety

General

 WARNING!	
	<p>WARNING! Danger by inappropriate installation!</p> <p>Inappropriate installation can cause severe injuries!</p> <p>Therefore:</p> <ul style="list-style-type: none"> – Only qualified personnel, authorised by the operator and instructed appropriately, may carry out installation tasks. – Prior to work, ensure that there is sufficient assembly space. – Pay attention to tidiness and cleanness at the assembly site! Loosely stacked or lying around components and tools are accident sources. – Ensure correct arrangement and correct fit on the components. – Install all fastening elements correctly.

Improper transport

 WARNING!	
	<p>WARNING! Danger by falling down or tilting of a pedestrian barrier!</p> <p>The weight of the pedestrian barrier or parts of it can seriously injure a person and cause serious crushing!</p> <p>Therefore:</p> <ul style="list-style-type: none"> – Have all transport work performed by trained personnel. – Depending on the dead weight and size of the components, use a pallet on which the barrier module can be moved by means of a forklift. – For lifting a pedestrian barrier or heavy parts of it, use suitable lifting gear that is designed for the weight of the barrier. – Lifting and carrying the pedestrian barrier from the pallet should be done by a minimum of two people.

Assembly and installation

Heavy weight

⚠ WARNING!	
	<p>WARNING! Risk of injury when lifting heavy objects alone!</p> <p>The weight of heavy objects can severely injure a person!</p> <p>Therefore:</p> <ul style="list-style-type: none"> – Lifting and carrying the pedestrian barrier or heavy parts of it from the pallet should be done by a minimum of two people.

Improper transport

NOTICE!	
	<p>NOTICE! The pedestrian barrier can be damaged by improper transport!</p> <p>Substantial material damage can result from improper transport.</p> <p>Therefore:</p> <ul style="list-style-type: none"> – Have all transport work performed by trained personnel. – When unloading the packages and during in-plant transportation always proceed with greatest care and caution. – Observe the dimensions of the pedestrian barrier. – Loading, unloading as well as moving the pedestrian barrier must take place with greatest care. – Only remove packaging directly before assembly.

Personal protective equipment

The following must be worn during all assembly and installation work:

- Work clothes
- Protective gloves
- Safety shoes.

5.2 Requirements for assembly

The following steps are to be completed prior to assembly and installation:

- Laying the foundation
- Installing the empty conduits

5.3 Foundation and empty conduits



Note!

To provide trouble-free operation use separate conduits for data cables and mains cables.

The functional safety of the pedestrian barrier hinges on the accuracy of the foundation.

Foundation

The foundation must meet the following requirements:

- Have sufficient load-carrying capacity
- Have a skid-proof surface.
- Horizontal and even, max. deviations 2 mm/m
- Have sufficient thickness for the fastenings.

Empty conduits

The empty conduits must be positioned accurately to the drilling plan. Refer to Page 24, Fig. 4.

Assembly and installation

5.3.1 Foundation plan

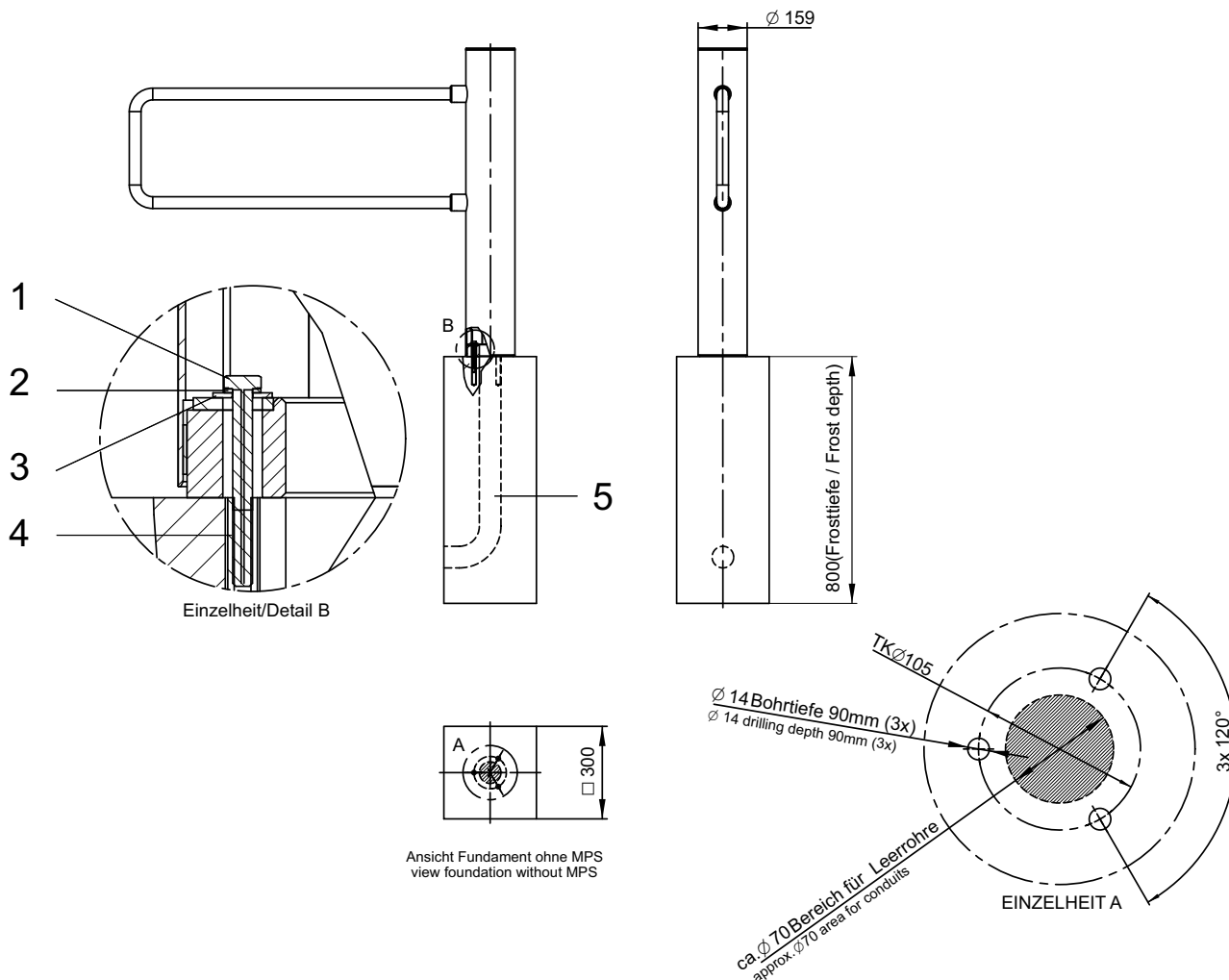

Fig. 4: Foundation plan

- 1 Recessed head screw M8 x 80
- 2 Spring washer
- 3 Disc
- 4 Tie anchor with inner thread M8
- 5 Empty conduits

- Have cables overlap the conduits by approx. 5 m
- Tie anchor with inner thread M8
- Drill hole diameter 14 mm, hole depth 90 mm
- Empty conduits for mains cable and data line
- Foundation level and horizontal
- Concrete or respective consistent industrial flooring
- In case of flagging make sure that the anchor bolts are secured firmly in the foundation. If necessary, use longer bolts.

5.4 Mounting the swing door MPS-122

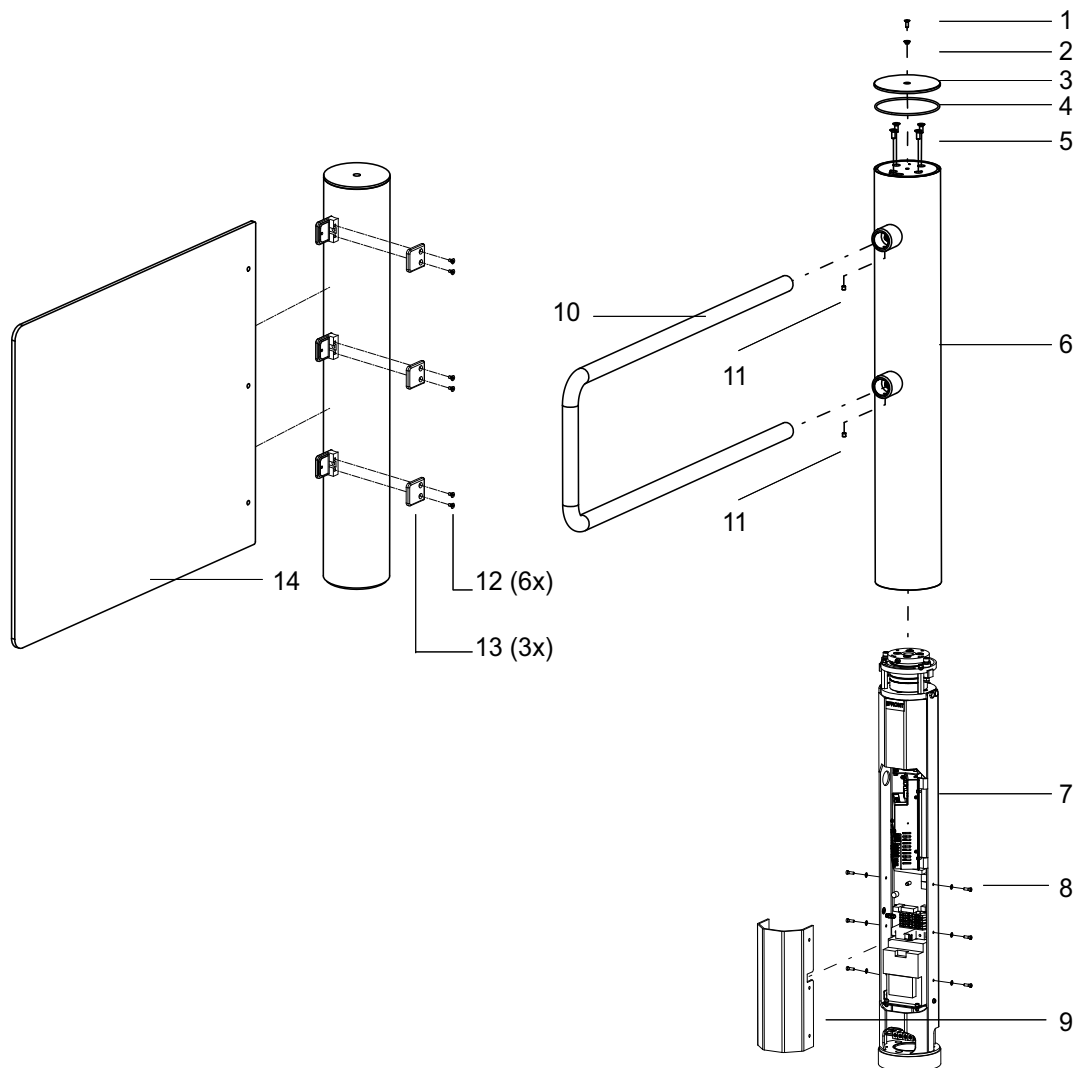

Fig. 5: Assemble swing door

- | | | | |
|---|---|----|------------------------|
| 1 | Recessed head screw M6 x16 | 8 | Disc/screws M5 x 16 |
| 2 | Insulating bush | 9 | Reinforcement |
| 3 | Top cover disc | 10 | Bracket |
| 4 | O ring | 11 | Threaded pin |
| 5 | Recessed head screws M8 x 20 | 12 | Recessed head screw M6 |
| 6 | Outer tube | 13 | Glass holder |
| 7 | Edge profile
(with drive, steering device and transformer) | 14 | Glass wings |

Assembly and installation

5.4.1 Mounting the swing door on the foundation



NOTE!

The swing door is delivered completely.

The swing door has to be partially disassembled before it can be mounted.

The foundation has set to the adequate hardness.

Foundation and empty conduits must be tested prior to commencing assembly.

The swing door is fastened with 3 tie anchors on the foundation. The mounting material is included in delivery.

1. Make the bore holes as per the drilling plan (see Page 24, Fig. 4).
2. Carefully remove any sand and swarf from the bore holes and their immediate vicinity.
3. Set the dowels supplied as shown on the enclosed description and allow hardening.



Fig. 6: Complete swing door.

The following work steps are required for mounting the swing door:



Fig. 7 and 8: Recessed-head screw and lid

1. Loosen lid-fastening recessed head screw M8 and remove it with the seal.
 - Do not allow the screws to come into contact with dust, sand or similar substances.

5.4.2 Disassemble swing door

1. Open the top cover of the support beam.



Fig. 9: Lid

2. Remove lid and remove O ring.



Fig. 10: Recessed head screws

3. Loosen and remove 4 recessed head screws M8.

Assembly and installation

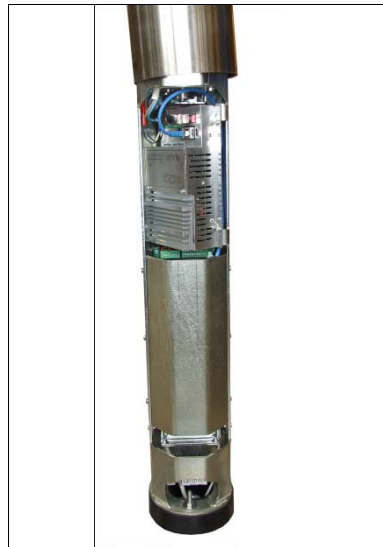

Fig. 11: Outer tube with bracket



Fig. 12: Cover

4. Pull outer pipe (Fig. 11) and bracket upwards and lift it off.
5. Loosen the screws and remove the cover (Fig. 12).

Use the mounting material included in delivery!

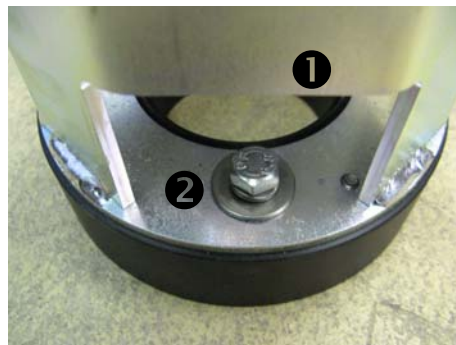

Fig. 13: MPS floor attachment

- 1 MPS standing tube
- 2 Screws M8, spring washer, washer (3 x each)



NOTE!

Observe curing time for the resin cartridge:

>20 °C	10 min
10 °C to 20 °C	20 min
0 °C to -10 °C	1 h
-5 °C to 0 °C	4 h



Assembly and installation

6. Place the standing tube in the intended position so that the cut-out in the casing as shown in Fig. 11 is approximately in a central position, pointing towards the desired home position.
7. Insert input lines from below.
8. Mark drill holes.
9. Put standing tube away again.
10. Drill 3 holes for anchor rods with inner thread M8.
11. Install 3 anchor rods with inner thread M8.
12. Fasten standing tube over threaded holes (do not damage empty conduits with cables).
13. Attach standing tube to the foundation with 3 screws M8.

6 Electrical connection

6.1 Safety

General

 WARNING!	
	<p>WARNING! Danger by inappropriate installation!</p> <p>Inappropriate installation can causes severe injuries or death.</p> <p>Therefore:</p> <ul style="list-style-type: none">– Only qualified personnel, authorised by the operator and instructed appropriately, may carry out installation tasks.– Pay attention to tidiness and cleanness at the assembly site! Loosely stacked or lying around components and tools are accident sources.– Install all fastening elements correctly.

Electric current**⚠ DANGER!****DANGER!****Mortal danger by electric current!**

Touching live parts can be lethal.

Damage to the insulation or to individual components can be lethal.

Therefore:

- Switch off the power supply immediately in case of damage to the insulation and arrange repair.
- Only qualified electricians may carry out work on the electrical system.
- Before starting work, ensure that the electrical system is powered down!
- Always turn the power supply off and safeguard against unintentional restarting before maintenance, cleaning, and repair work. Never bypass or deactivate fuses.
- Never bypass or deactivate fuses.
- When replacing fuses observe the correct amperage specification.
- Keep moisture away from live parts, this can result in short-circuit.

Safety devices:

The following safety equipment has to be installed on site. The safety equipment is to be provided by the customer.

- Residual current device (RCD)
- Residual current device (RCD)
- Circuit-breaker

Electrical connection

6.2 Supply voltage connection

6.2.1 Connecting the supply voltage

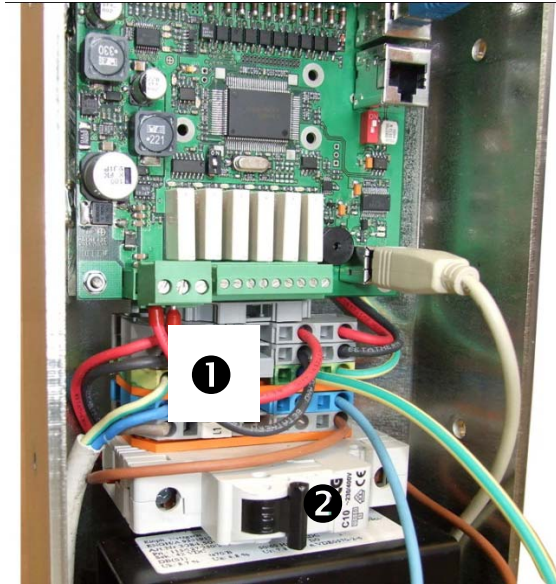

Fig. 14: Grid connection

- 1 Terminals L, N, PE
- 2 2-pin main switch

Connect the power cable only to the correct terminals L, N, PE (1).
The 2-pin main switch (2) isolates the entire unit.

6.2.2 Connect control lines to MBC-111

The control and feedback lines are connected at the control device MBC-111 (see included circuit plans).

7 Assemble MPS column

Danger of being crushed

⚠ CAUTION!	
	<p>CAUTION! Danger of being crushed!</p> <p>A moving swing door can cause crushing.</p> <p>Therefore:</p> <ul style="list-style-type: none">– Pay the utmost attention when installing, setting and performing maintenance at the swing doors.

1. Switch on main switch (1) (Fig. 14).
2. Fasten cover (9) with 6 cylinder head screws.
3. Replace outer tube.
4. Attach brackets or glass wings to the outer tube, depending on version.
5. Attach locking bracket to the outer tube with 2 threaded pins.
6. Attach glass wings to outer tube with glass holder and recessed head screws M6.
7. Turn the outer tube so that the slot in the upper cover plate is about at the centre over the limit screw.



Fig. 15: Limit screw alignment

8. Reattach the 4 recessed head screws M8 and tighten them. Do not install cover yet.

Assemble MPS column

7.1.1 Setting the two mechanical end stops

1. Turn the outer tube with the locking bracket (glass wings) to the right until the limit screw touches the right end stop.
2. Loosen the screw of the right end stop and move it until it is about 92° to the right of the desired home position.

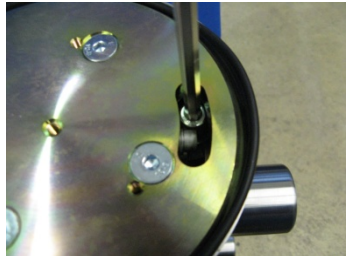

Fig. 16: Set right end stop

3. Re-tighten the screw.
4. Turn the outer tube with the locking bracket (glass wings) to the left until the limit screw touches the left end stop.
5. Loosen the screw of the left end stop and move it until it is about 92° to the left of the desired home position.
6. Re-tighten the screw.

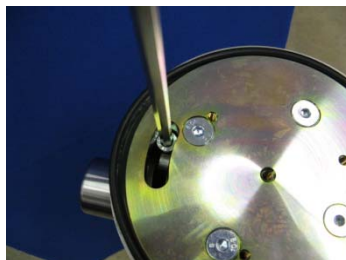



Fig. 17: Set left end stop

7. Mount locking bracket (glass wings).
8. Take barrier into operation (see chapter on commissioning) and check that the positions can be assumed correctly. If the positions are not assumed correctly, realign end stops.
9. Re-insert o ring.
10. Replace lid.
11. Screw on lid with o-ring and recessed-head screw M8.

8 Commissioning

8.1 Safety

General

⚠ WARNING!	
	<p>WARNING! Danger by inappropriate start-up and operation! Inappropriate start-up and operation can cause severe injuries or death.</p> <p>Therefore:</p> <ul style="list-style-type: none"> – Before start of works ensure that the outer tube is mounted correctly.

Electric current

⚠ DANGER!	
	<p>DANGER! Mortal danger by electric current! Touching live parts can be lethal. Damage to the insulation or to individual components can be lethal.</p> <p>Therefore:</p> <ul style="list-style-type: none"> – Switch off the power supply immediately in case of damage to the insulation and arrange repair. – Only qualified electricians may carry out work on the electrical system. – Before starting work, ensure that the electrical system is powered down! – Always turn the power supply off and safeguard against unintentional restarting before maintenance, cleaning, and repair work. Never bypass or deactivate fuses. – Never bypass or deactivate fuses. – When replacing fuses observe the correct amperage specification. – Keep moisture away from live parts, this can result in short-circuit.

Commissioning

8.2 Commissioning

Inspection prior to initial start-up

The following inspections must be performed prior to initial start-up:

- Ensure that the swing door can go into operation without hindrance. The driving path of the locking bracket must be clear.
- Switch on the supply voltage
- At first start-up, the software for the motor control device MMC-120 may first have to be loaded from the logic control device. This process may take up to 1 minute. Please do not switch off the supply voltage during this time. Otherwise, the process must be repeated. When the supply voltage is switched on again later, this process is not required.
- The swing doors then perform homing. That means that they first move to the mechanic end stop and then to their home position.
- Digital in- and outputs at the control device MBC-111 control the swing doors.



NOTE!

If you want to change functions or parameters, read the chapter "programme MPS-Diag". For this, you require a laptop/PC with the Windows software MPS-Diag.

9 Function description MBC 111

9.1 Digital inputs

9.1.1 Technical data for the inputs

- all inputs are insulated by opto couplers
- Input voltage 24V \pm 10%
- Input current 10 mA per input
- Impulse length for inputs 100 ms to 300 ms

9.1.2 Function of digital inputs

Input	Function	Description
1	Emergency situation (Emergency)	<p>This input enables free passage of the swing doors in case of an emergency. The input is fail-safe, i.e. the swing door is only operative when a continuous signal is present.</p> <p>When the continuous signal disappears, the motor is switched off immediately. The locking bracket can be moved freely.</p> <p>The input acts directly on the motor end stage through a second channel. It is superordinate over all other inputs. If several swing doors are to be opened at the same time using an external emergency STOP switch, the inputs must be insulated with additional relays to avoid coupling of the voltages between the different swing doors</p>
2	Open passage left	<p>Opening pulse for passage to the left.</p> <p>If the signal continues to be present, the hold-open time is re-triggered.</p>
3	Open passage right	<p>Opening pulse for passage to the right.</p> <p>If the signal continues to be present, the hold-open time is re-triggered.</p>
4	Shutting superordinate (locking)	<p>Input for superordinate closing of the barrier. No opening signals are accepted anymore. This input can be used to lock the barrier. Input 1 (emergency) remains superordinate; i.e. even when the barrier is locked, the barrier can still be opened completely.</p>
5	Manual reset	<p>Input for manually resetting the controller after voltage outages. Input is only required when the function "manual reset" was also activated.</p>
6 to 9	Not reserved	–

Table 5: Digital inputs

Function description MBC 111

9.2 Relay outputs

9.2.1 Technical data for the outputs

- Isolated relay contacts, wired in groups
- Switched voltage 5 – 48V
- Switched current 10 mA – 1 A

9.2.2 Function of the outputs

Relay output	Function	Description
K1	Global error and alarm output (voltage outage)	<p>When certain errors occur, a continuous signal is given at this output; it continues as long as the error persists. Refer also to the following note.</p> <p>Possible errors are:</p> <ul style="list-style-type: none"> ■ Lock runtime too long = obstacle detected ■ CAN communication with end stage is impaired ■ Hardware error in end stage ■ Software error in end stage ■ Homing function running ■ Power failure ■ Manual reset expected (only if fitted)
K2	Locking bracket in home position	A permanent signal is delivered via this output for as long as the locking bracket is in its home position.
K3	Locking bracket in left end position	A permanent signal is delivered via this output for as long as the locking bracket is in its left end position.
K4	Locking bracket in right end position	A permanent signal is delivered via this output for as long as the locking bracket is in its right end position.
K5	Counting pulse when the left end position is reached	A counting pulse lasting 500 ms is delivered via this output when the left end position is reached.
K6	Counting pulse when the right end position is reached	A counting pulse lasting 500 ms is delivered via this output when the right end position is reached.

Table 6: Relay outputs



NOTE!

Voltage outage is indicated at the global error output; therefore, relay 1 is operated invertedly. This means that the relay is closed as long as there is no error. As soon as one the global errors described above occurs, the relay falls off.

9.3 Diagnosis display

9.3.1 Function of diagnosis display

There is an LED display for diagnosis purposes in the MBC-111. For reading the LED display, you must remove the outer tube with the locking bracket. We recommend reading errors through the MPS-Diag diagnosis programme via the serial interface.

Error code	Error description	Automatic reset
01	Obstacle detection with runtime monitoring	Yes
02	Emergency entrance is activated	Yes
05	Locking bracket was pushed into the wrong direction	Yes
07	Vandalism detection	Yes
20	Error MMC control device	No
21	MMC control device output stage cannot be activated	No
22	Lifeguarding error MMC	No
40	Homing error	No
41	Wrong programme mode	No
50-57	Software error	No
5D	Checksum error EEPROM	No
5E	Checksum error Flash	No
5F	Watchdog error	No
60	Error when initialising CAN protocol stack	No
61	Error when initialising CAN bus	No
62	CAN servo address error	No
63	Error download of controller parameters for MMC-120	No
64	Reserved	No
65	Error I ² C-EEPROM	No
66	Software error	No
70 to 7F	Error when downloading MMC-120 firmware	No

Table 7: Error code

Self-resetting errors are displayed for no more than 20 seconds if the error is no longer pending. As long as the error is pending, the error code is shown.

In case of non-self-resetting errors, the barrier is taken out of operation. The error code is shown permanently until the control is taken into operation again after the error is removed.

Function description MBC 111

9.3.2 CAN bus addressing and termination

The MBC-111 logic controller and the MMC-120 motor controller exchange data via a CAN bus line. The MMC-120 controllers must have a fixed CAN address assigned to it. Additionally, a termination resistor must be activated at both ends of the bus to prevent interference.

Setting the CAN address and termination is performed by DIP switches for both control devices.

The following DIP switch settings are correct:

Function	DIP switch	MBC-111	MMC-120
Termination	1	ON	ON
CAN address	2	OFF	OFF
	3	OFF	OFF
	4	OFF	OFF

Table 8: Setting of the DIP switches

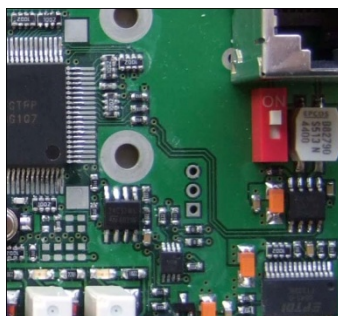

Fig. 18: DIP switch
CAN MBC-111

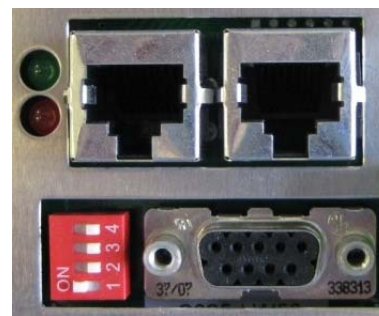

Fig. 19: DIP switch
CAN MMC-120



NOTE!

Wrong settings for the DIP switch can lead to the swing doors not going into operation or to malfunctions during operation.

10 Mode: MPS Standard

10.1 Power-off state

When there is no voltage, the motor is powered down. It is unlocked. The swing doors can be turned freely.

10.2 Start-up routine

After switching on the operation voltage, the reset version set is checked first.

In case of the setting "manual reset", the control is first waiting for a reset pulse at the "manual reset" input and then performs homing. With the "autoreset" setting, homing is performed at once.

10.3 Homing

The barrier performs "homing" first. That means that it first determines where the locking bracket is by finding the mechanical end stop. This is performed at a reduced speed and with reduced torque. During "homing", the horn emits a warning signal. Depending on whether the left or right gate was chosen, homing is performed in different directions.

For the left gate, the locking bracket slowly turns clockwise after voltage is switched on, until the mechanical end stop is reached. After the end stop is reached, the locking bracket continues to move at a slow speed counter-clockwise into the position defined as the home position (default 90°). When the home position is reached, the MPS is ready for operation.

For the right gate, the locking bracket slowly turns counter-clockwise after voltage is switched on, until the mechanical end stop is reached. After the end stop is reached, the locking bracket continues to move at a slow speed clockwise into the position defined as the home position (default 90°). When the home position is reached, the MPS is ready for operation.

Depending on whether or not the function "brake locks in home position" is activated, the brake is activated when the home position is reached.

Mode: MPS Standard

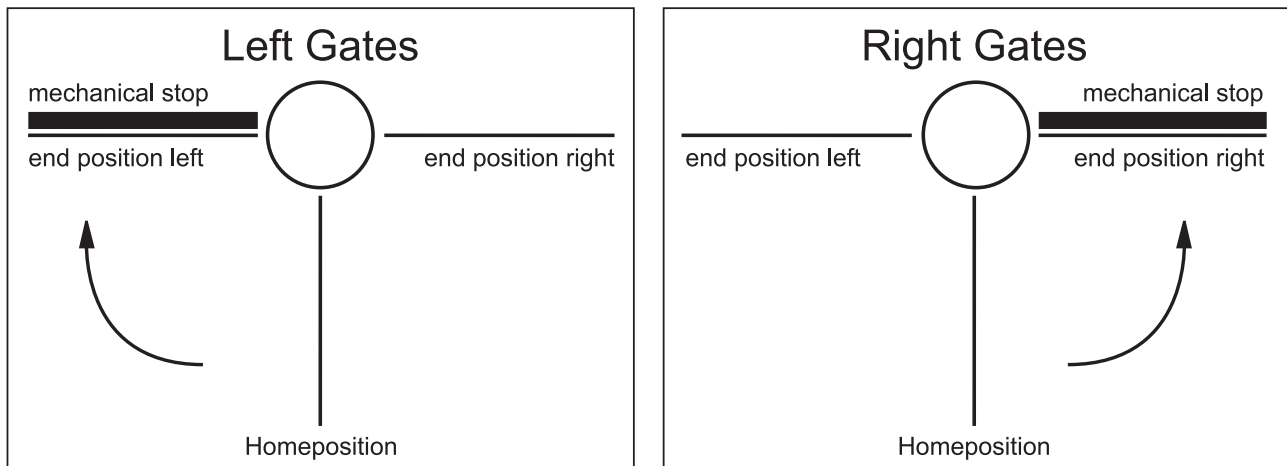

Fig. 20: Homing for the left and right gates

10.4 Normal motion

In the three possible positions, the swing door is held by the motor at a low torque. If the function "activate brake" was selected for one or several positions, the motor is powered down in this position and the brake is switched on instead.

When none of the two opening directions is cleared, the locking bracket is in its home position. The brake is always activated when someone tries to move the turnstile from the home position (see special cases).

After the clearance pulse is received for one direction, the barrier is opened into the pass-through direction. When the end position is reached, the locking bracket is either held in place by the motor, or by activating the brake (depending on the function set).

After the end of the hold-open time, the barrier closes again automatically. This means, the locking bracket moves back into the home position.

10.5 Special cases within motion sequence

10.5.1 Obstacle recognition during motion

The locking bracket can be stopped during motion, e.g. when a user does not move on or if a piece of luggage is caught. Depending on the function selected, one of the following measures is performed:

- No reaction.
- The locking bracket continues to press with a lower force and speed.
- The locking bracket returns to its original position and restarts the motion at once.
- The locking bracket moves back slightly and continues in the original direction.

10.5.2 Turning back during motion

If someone tries to push the locking bracket into the wrong direction during motion, the brake is activated at once. After a pause, the brake is released again. If the user continues to press into the wrong direction, it is immediately reactivated, etc.

Otherwise, the locking bracket continues to turn into the original direction when the lock is released and stops when the end position is reached.

10.5.3 Attempted vandalism

In the rest position, the barrier is locked. If the locking bracket is moved with a force larger than the maximum holding force, the brake gives way and catches again at once, etc. It is thus possible to turn the bracket in small steps. When the vandalism attempt is stopped, the locking bracket returns to its original end position.

10.5.4 Emergency

When the input IN1 "Emergency" is interrupted during operation, the lock goes into safe mode. Motor and lock are powered down at once. The control system returns to operation when there is voltage again at the input IN1.

MPS-Diag programme

11 MPS-Diag programme

The swing doors MPS-122 is configured ex works so that it can be operated without additional programming for applications with an opening angle of $2 \times 90^\circ$ kann.

If you want to change function and parameter settings on-site, you can use the programme MPS-Diag.

You will also require a laptop/PC and an USB extension.

System requirements

- Windows as of WIN 2000
- USB interface as of 1.1
- Programme and operating instructions on included flash drive

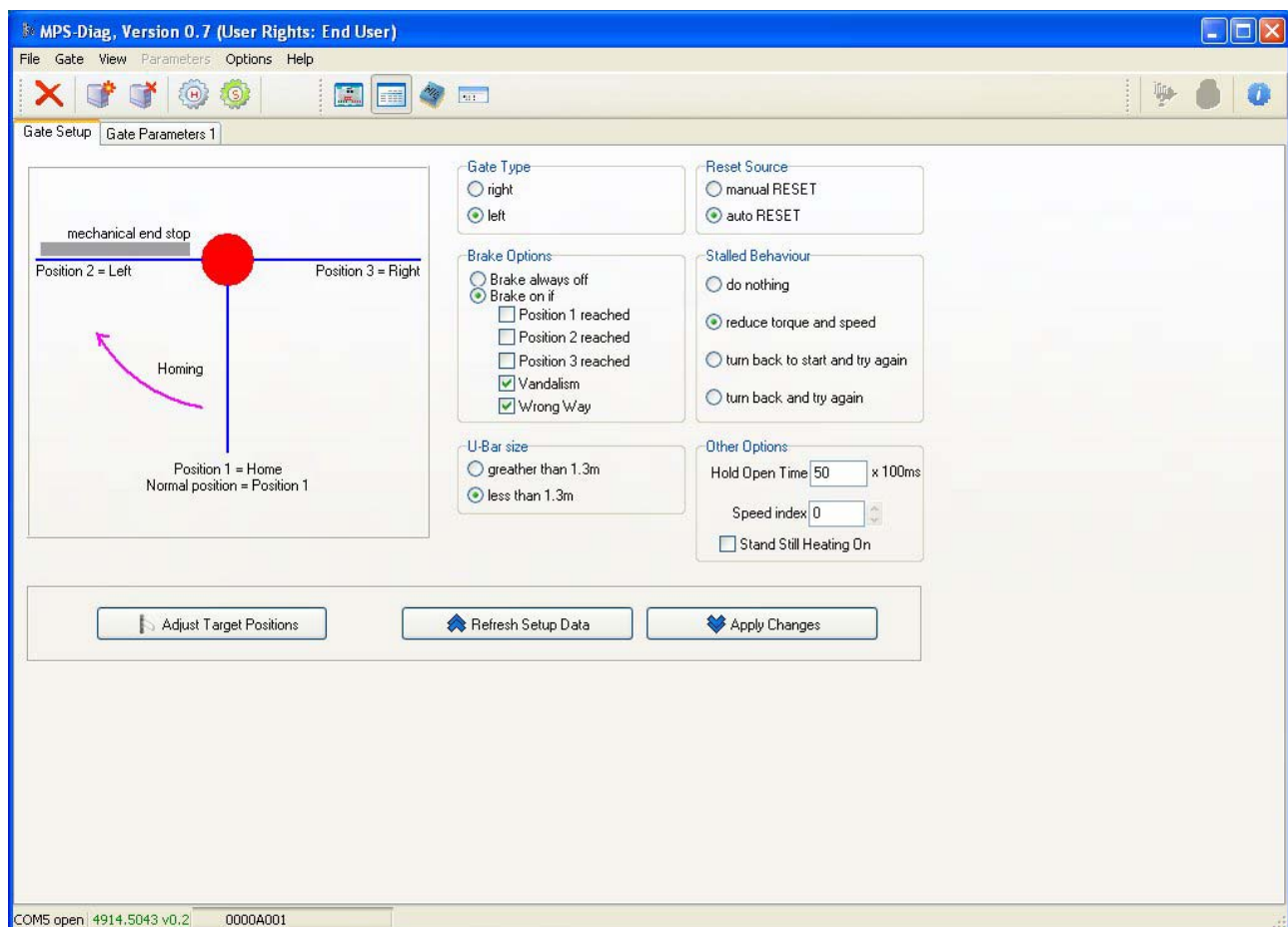

Fig. 21: MPS-Diag programme

11.1 Connect laptop to control device MB-111

The USB cable can only be plugged in after the outer tube with the locking bracket is removed.

The connection cable is in the socket area.

Connect the MBC-111 with a normal USB extension.

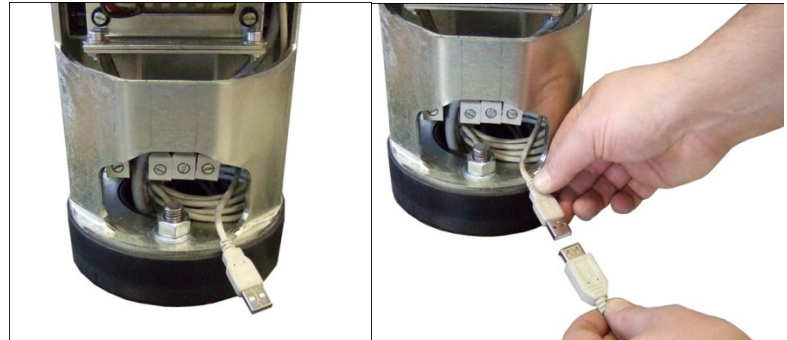

Fig. 22: Connection for USB plug with extension

11.2 Using the MPS-Diag programme

1. Installing the MPS-Diag programme on a laptop or PC.
2. Start the included programme MPS-Diag Setupxxx.exe and observe the instructions of the installation routine.
3. During installation, a virtual COM port driver is installed. The port number of the serial interface can be determined as follows:
 - Plug in connection cable.
 - Use the menu "Device Manager -> Connections (COM and LPT)" to read the port number.
4. Start MPS-Diag programme
5. Select your computer's COM port in the "Settings" menu.

MPS-Diag programme

11.3 Function and Parameter Settings

Function and parameter settings are made through the Windows programme MPS-Diag.

The following functions can be set:

- Design left / right
- Brake activated / not activated in the three positions, in case of vandalism or when pressed in the wrong direction
- Setting the locking bracket size used
- Reset source
- Behaviour when obstruction detected
- Hold-open time
- Speeds
- Heating active while standing
- Programming the two end positions and the home position
- Resetting all parameters to factory settings

11.3.1 Design left / right

This option informs the control if the swing door is a right or left design version. In a right gate, the barrier turns against the right mechanic end stop during homing. In a left gate, the barrier turns against the left mechanic end stop during homing.

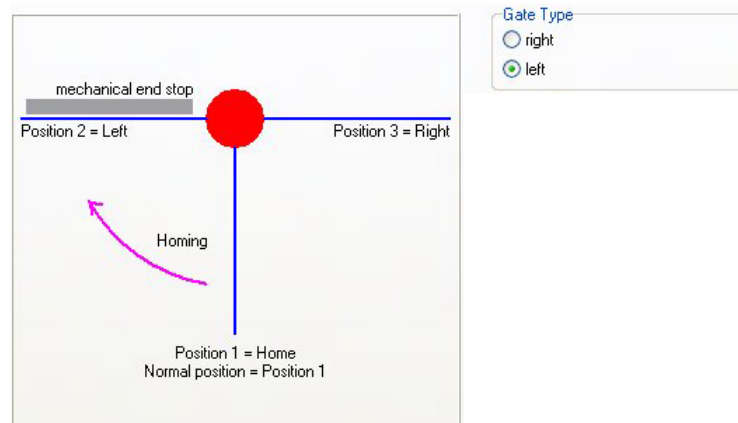

Fig. 23: Example for left gate 2 x 90°

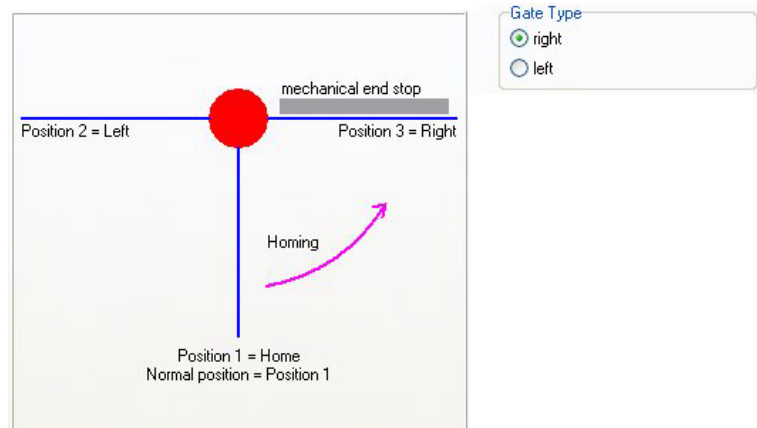

Fig. 24: Example for right gate 2 x 90°

11.3.2 Brake activated / not activated

This option is used to inform the control if the brake is to be activated when one of the three positions is reached, in case of vandalism or when pressed in the wrong direction. The setting can be made independently for each of the five options.

Brake Options

Brake always off

Brake on if

- Position 1 reached
- Position 2 reached
- Position 3 reached
- Vandalism
- Wrong Way

Fig.25: Possible settings for the brake

11.3.3 Selecting the locking bracket size

This option can be used to select the locking bracket length.



Fig. 26: Select bracket size

11.3.4 Select reset source

This option can be used to specify whether, once power has been restored, the controller first waits for a pulse at the "manual reset" pulse or whether it starts to home immediately.

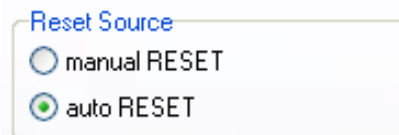

Fig. 27: Select reset source

11.3.5 Behaviour when obstruction detected

This option is used to determine the behaviour of the barrier when an obstacle is detected.

- Nothing: No reaction.
- Reduce force and speed: The locking bracket continues to press with a lower force and speed.
- Rev completely and start new: The locking bracket returns to its original position and restarts the motion at once.
- Rev slightly and start new: The locking bracket moves back slightly and continues in the original direction.

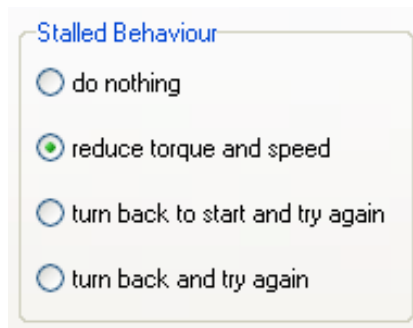
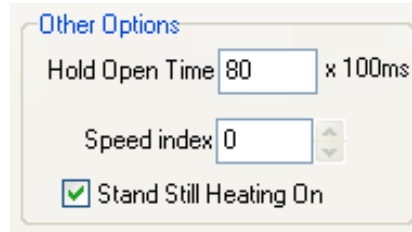

Fig. 28: Behaviour when obstruction detected

11.3.6 Set hold-open time

The "hold-open time" parameter is used to set the hold-open time between 0 and 25 seconds in steps of 100 ms. Entering 50 means 5 seconds.



Other Options

Hold Open Time x 100ms

Speed index

Stand Still Heating On

Fig. 29: Set hold-open time

11.3.7 Set speed

The "speed" parameter is used to set one of three speeds (0 = slow / 1 = medium / 2 = fast). This speed applies for normal operation.

When the bracket length is more than 1.30 meters, only speed "0 = slow" is available.

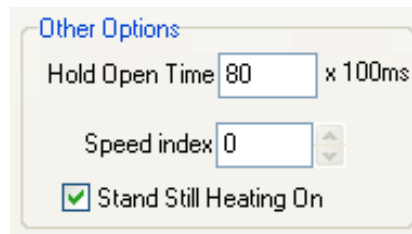

Other Options

Hold Open Time x 100ms

Speed index

Stand Still Heating On

Fig. 30: Set speed

11.3.8 Heating active while standing

This option is used to determine if heating is activated while standing. Heating is required when the barrier is used in ambient temperatures of less than 0°C.

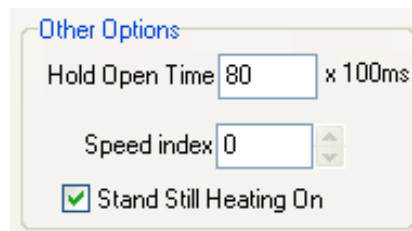

Other Options

Hold Open Time x 100ms

Speed index

Stand Still Heating On

Fig. 31: Switch on standing heating.

MPS-Diag programme

11.3.9 Teaching the three possible positions

The MPS is delivered with 2 x 90° opening angles by default. However, the three positions can be changed independently. For this, there is an input mask in MPS-Diag.

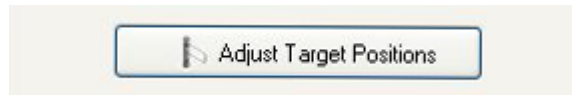
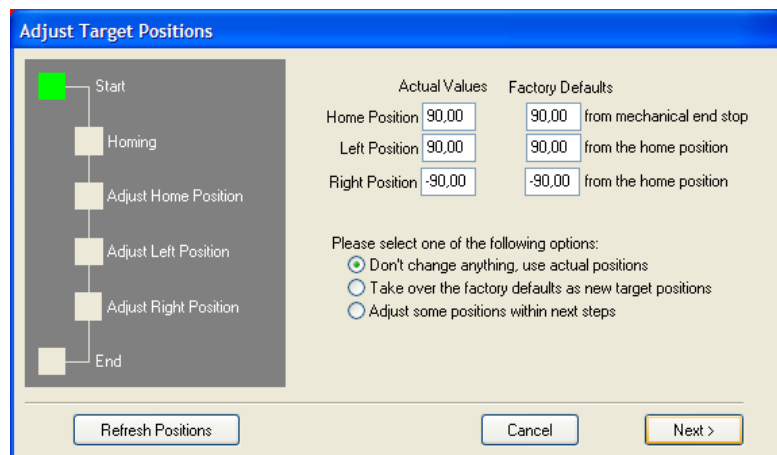

Fig. 32: Activate screen mask for adjusting the target positions

Setting the target positions is a process with several stages.



	Actual Values	Factory Defaults	
Home Position	90,00	90,00	from mechanical end stop
Left Position	90,00	90,00	from the home position
Right Position	-90,00	-90,00	from the home position

Please select one of the following options:

- Don't change anything, use actual positions
- Take over the factory defaults as new target positions
- Adjust some positions within next steps

Fig. 33: Setting the target positions

1. Perform homing. Put the MBC control into service mode for this. Then you can adjust the three positions.

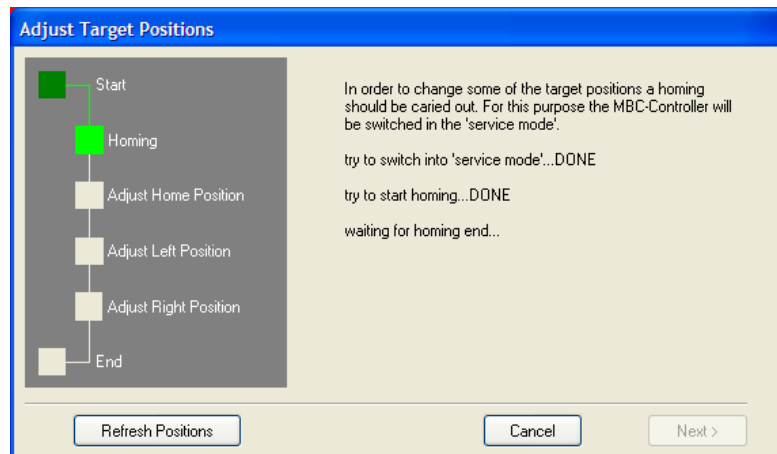

In order to change some of the target positions a homing should be carried out. For this purpose the MBC-Controller will be switched in the 'service mode'.

try to switch into 'service mode'...DONE

try to start homing...DONE

waiting for homing end...

Fig. 34: Perform homing

2. Adjust "home position".

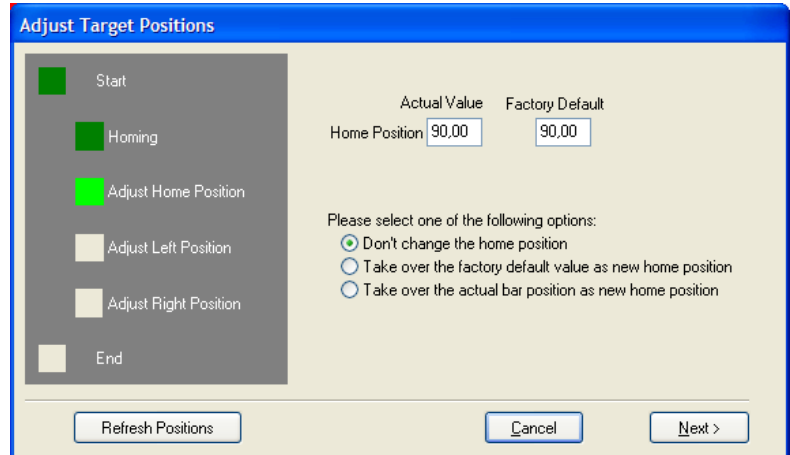

Adjust Target Positions

Start

Homing

Adjust Home Position

Adjust Left Position

Adjust Right Position

End

Actual Value Factory Default

Home Position

Please select one of the following options:

Don't change the home position

Take over the factory default value as new home position

Take over the actual bar position as new home position

Fig. :35 Adjust home position

3. Adjust "left position".

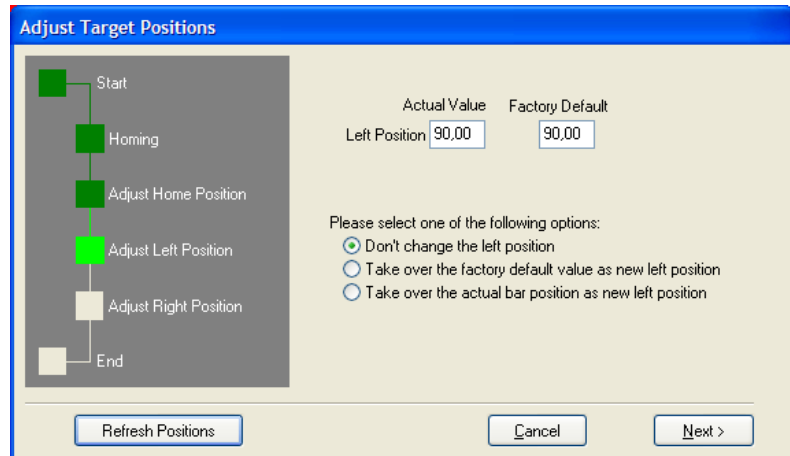

Adjust Target Positions

Start

Homing

Adjust Home Position

Adjust Left Position

Adjust Right Position

End

Actual Value Factory Default

Left Position

Please select one of the following options:

Don't change the left position

Take over the factory default value as new left position

Take over the actual bar position as new left position

Fig. 36: Adjust "left position"

4. Adjust "right position".

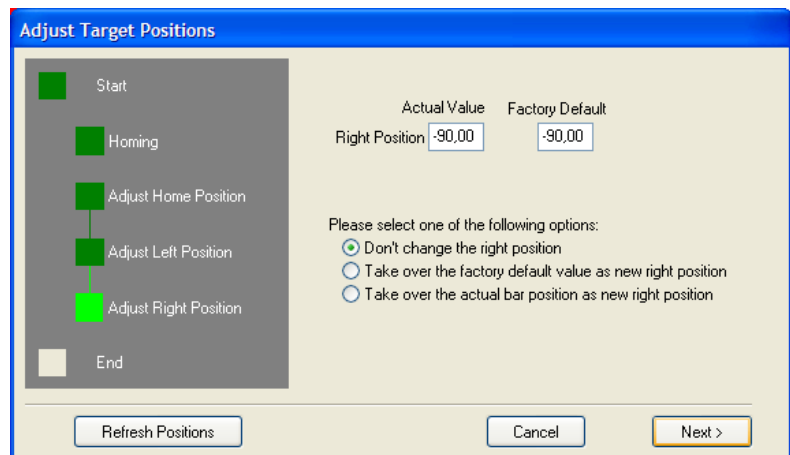

Adjust Target Positions

Start

Homing

Adjust Home Position

Adjust Left Position

Adjust Right Position

End

Actual Value Factory Default

Right Position

Please select one of the following options:

Don't change the right position

Take over the factory default value as new right position

Take over the actual bar position as new right position

Fig. 37: Adjust "right position"

- Confirm changes by clicking the button "Close". The MBC control is restarted.

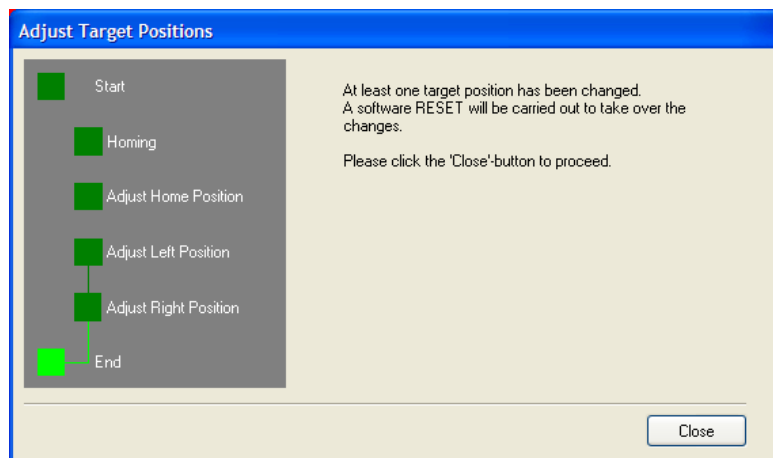

Fig. :38 Reset control MBC

11.3.10 Reset all parameters to factory settings

This option can be used to restore the factory settings for all parameters.

- Open menu "View" and select the item "Parameter".



Fig. 39: Menu "Parameter"

- The menu "Parameter" is displayed in the title bar.
- Click menu "Parameter"
- Select menu item "Restore all parameters to factory settings"



Fig. 40: Select menu item "Restore all parameters to factory settings"

5. Safety confirmation "All parameters are reset to factory settings. Do you want to continue?"

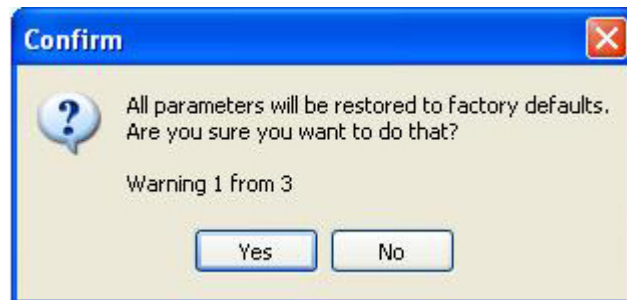

Fig. 41: Safety confirmation

- Clicking "Yes" resets all parameters to factory settings.
- Clicking "No" cancels the process.

11.4 Firmware download

To update the control device firmware, the "MPS-Diag" programme is needed.

1. Open menu "View" and select the item "Firmware".

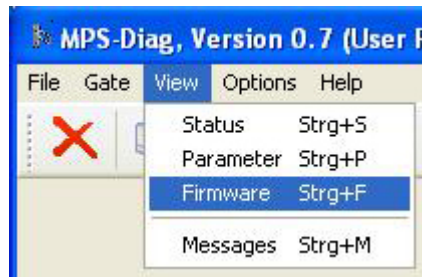

Fig. 42: Menu "View"

MPS-Diag programme

2. A dialogue window appears. The dialogue window display depends on the control type. If communication with the control is impossible, the MBC field will show a question mark.

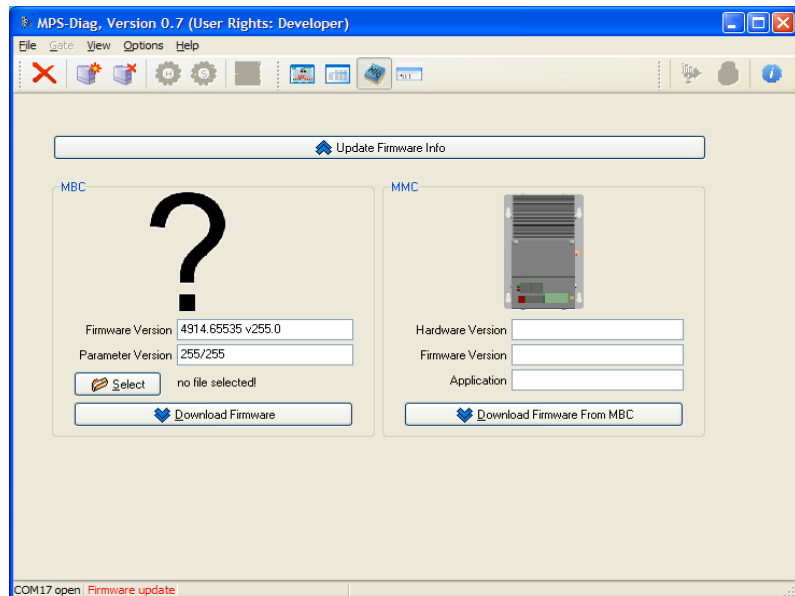

Fig. 43: Menu "Firmware update" (here: no communication)

When communication to the control is present, proceed as follows for downloading a new firmware version:

3. Select the firmware file through the button "Select".
4. Click the button "Download Firmware".

The further process depends on the control type and the file selected. For a MBC111 control, the file type chosen should be a ".mcp" file.

You may also select an ".s" file (Motorola S-Record). This download will take longer.

11.4.1 Firmware download using a ".mcp file"

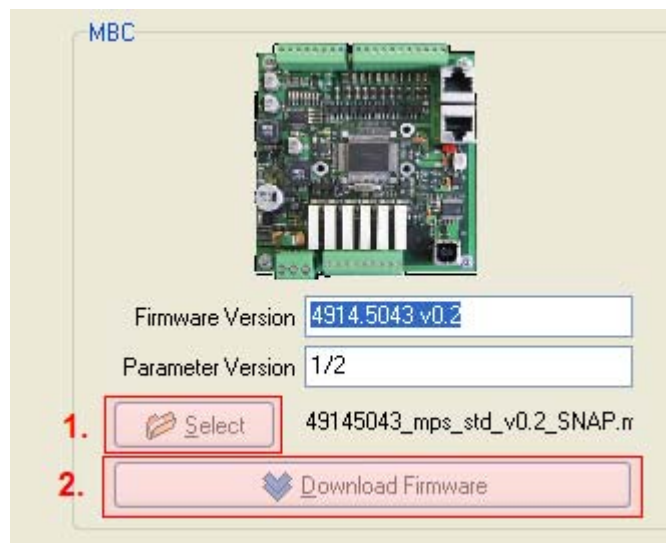

Fig. 44: Button "Download Firmware"

1. After clicking the button "Download firmware", the programme status bar shows the download progress.

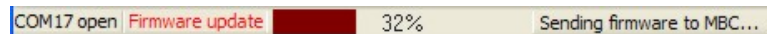

Fig. 45: Download progress

2. When the download is completed, perform voltage reset.

11.4.2 Firmware download using an ".s file"

Only use firmware download using an ".s" file with a MBC111 control if the bootloader is no longer accessible.

1. Select the firmware file through the button "Select".
2. Select the file type in the file selection dialogue.

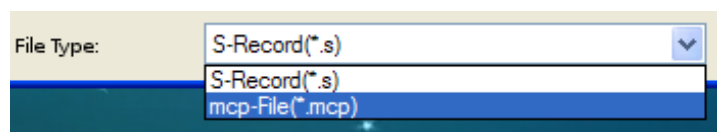

Fig. 46: File type selection

3. Click the button "Download Firmware".
4. Select the integrated control with the dialogue window "Control selection".

MPS-Diag programme

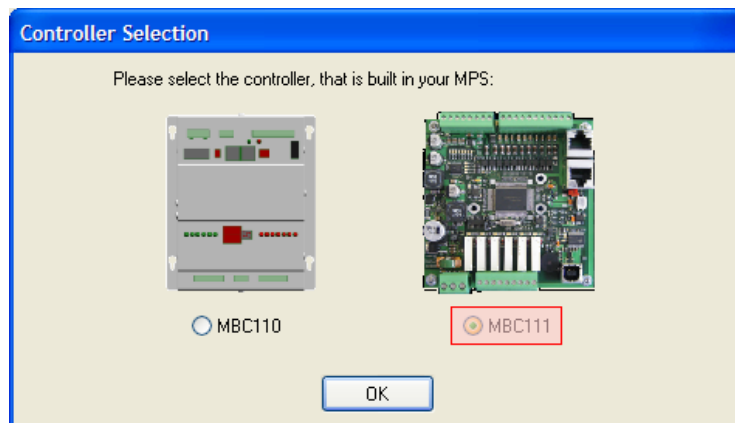

Fig. 47: Control selection

5. The dialogue "Confirmation" is displayed.

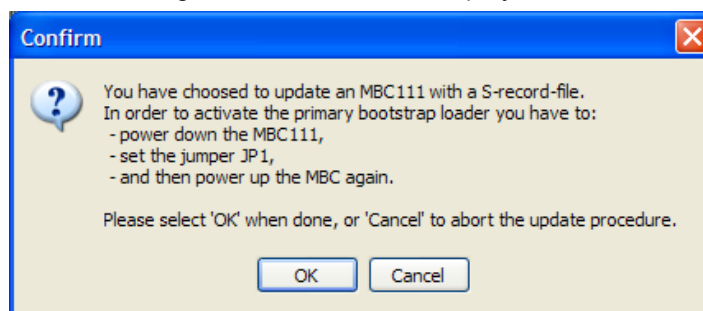

Fig. 48: Dialoge "Confirmation"

6. Observe the dialogue instructions precisely.
7. When you have performed all steps, click the "OK" button.
8. When the connection to the bootloader is established, the download will start. The download progress is displayed in the status bar.
9. After firmware transmission the "Information" dialogue is shown.

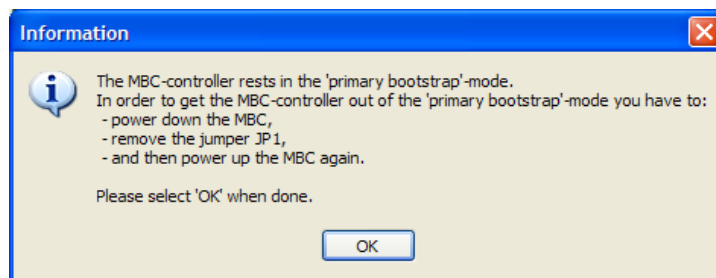

Fig. 49: Dialog "Information"

10. Observe the dialogue instructions precisely.
11. When you have performed all steps, click the "OK" button. The download is completed.

11.5 Download between MBC-111 and MMC-120

Each time the MBC-111B is booted after voltage is switched on again, software verification is performed between the MBC-111 and the connected motor control device MMC-120. It verifies that the motor control device has the right software and the right software version for the MBC-111 application software.

If verification shows that the motor control device has the wrong software or software version, the correct software is automatically loaded from MBC-111 to MMC-120. The software can also be manually loaded from MBC-111 to MMC-120 through the Windows programme MPS-Diag.

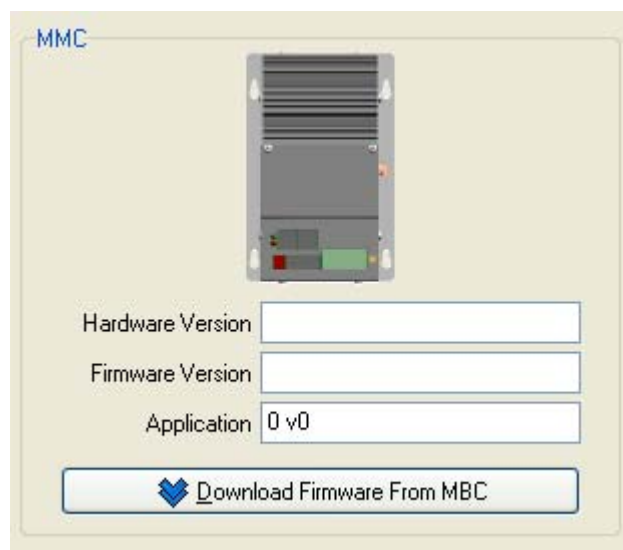

Fig. 50: Programming via the MPS-Diag programme

MPS-Diag programme

11.6 Reading errors

Error codes can only be read directly at the MBC-111 or MMC-120 after the outer tube with the locking bracket is removed. Therefore, the programme MPS-Diag offers the possibility of reading errors from the MBC-111 and MMC-120 controls through the serial interface.

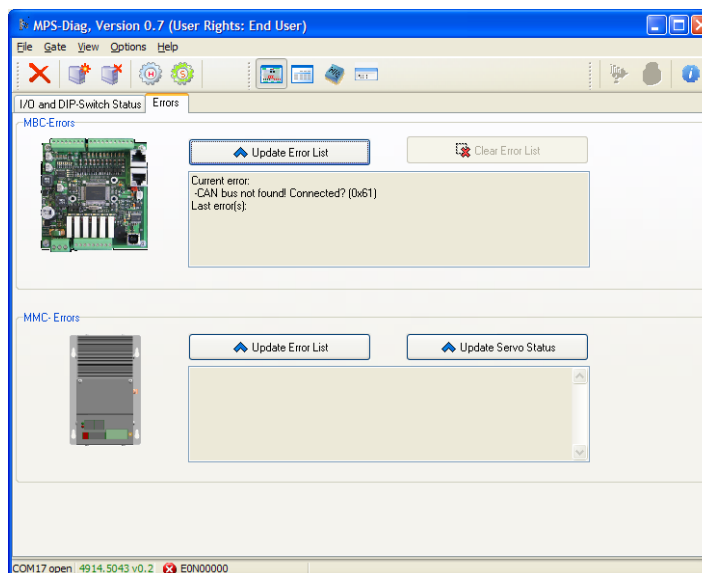

Fig. 51: Reading MBC-111 and MMC-120 errors

11.7 Status request

The status at the in- and outputs can only be read directly at the MBC-111 after the outer tube with the locking bracket is removed. Therefore, the programme MPS-Diag offers the possibility of reading the status of the in- and outputs through the serial interface.



NOTE!

The states of the DIP switches for parametrisation of the CAN bus cannot be read via MPS-Diag. This is only possible directly at the control. Therefore, these settings must be checked before the MPS is assembled!

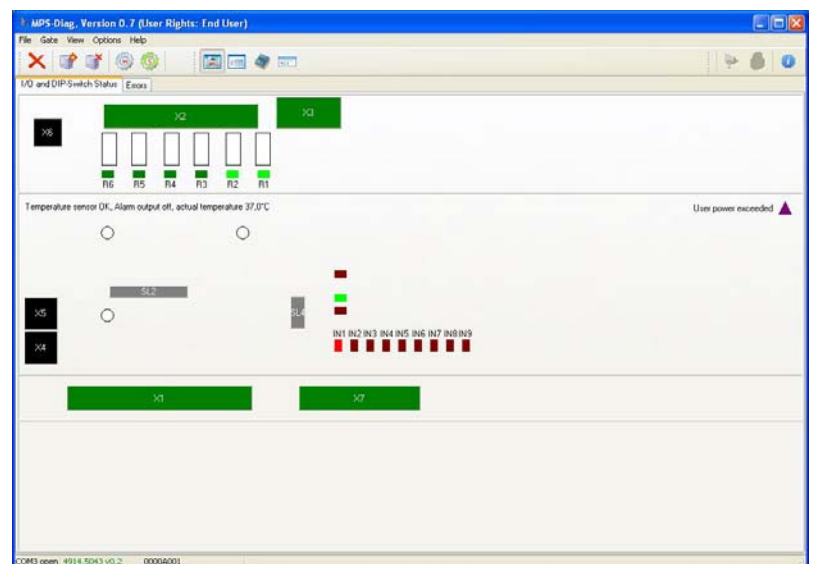



Fig. 52: Reading states of the inputs and outputs and DIP switches

12 Maintenance

12.1 Safety

General

 WARNING!	
	<p>WARNING! Danger by inappropriate maintenance!</p> <p>Inappropriate start-up and operation can cause severe injuries or death.</p> <p>Therefore:</p> <ul style="list-style-type: none">– Only qualified personnel, authorised by the operator and instructed appropriately, may carry out maintenance tasks.– Prior to work, ensure that there is sufficient assembly space.– Pay attention to tidiness and cleanness at the assembly site! Loosely stacked or lying around components and tools are accident sources.– If components have been replaced: Pay attention to correct installation of the spare parts. Reinstall all fastening elements correctly.– Before restarting, ensure that all doors locked properly.

Electric current**⚠ DANGER!****DANGER!****Mortal danger by electric current!**

Touching live parts can be lethal.

Damage to the insulation or to individual components can be lethal.

Therefore:

- Switch off the power supply immediately in case of damage to the insulation and arrange repair.
- Only qualified electricians may carry out work on the electrical system.
- Before starting work, ensure that the electrical system is powered down!
- Always turn the power supply off and safeguard against unintentional restarting before maintenance, cleaning, and repair work. Never bypass or deactivate fuses.
- Never bypass or deactivate fuses.
- When replacing fuses observe the correct amperage specification.
- Keep moisture away from live parts, this can result in short-circuit.

Personal protective equipment

The following must be worn during maintenance work:

- Work clothes
- Protective gloves
- Safety shoes.

Maintenance

12.2 Cleaning

Aggressive cleaning aids and substances

NOTICE!	
	<p>NOTICE! Unit damage possible!</p> <p>Aggressive cleaning agents and substances can damage or destroy electrical cables and components.</p> <p>Therefore:</p> <ul style="list-style-type: none"> – Do not use cleaning agents with aggressive ingredients.

Carrying out cleaning work:

1. Switch off power supply and secure against restarting.
2. Remove soiling appropriately.
 - Clean stainless steel surfaces and power-coated parts regularly with a damp cloth and then dry off carefully.
 - Clean stainless steel surfaces with an appropriate detergent. We recommend 3M stainless steel polish. Apply a thin and even layer of stainless steel detergent and rub dry using a clean and dry disposable cloth.
 - Never use wet cloth.
 - Wash off zinc surfaces using water and a soft cloth. Remove stubborn marks as soon as possible using a standard commercial detergent for zinc (e.g. ROTOL New Formula A2).
3. Absorb lubrication and grease deposits with absorbing materials.
4. After cleaning, check that all previously opened covers have been properly closed and that the functions of any safety equipment fitted have been restored.

12.3 Maintenance schedule

The following describes the maintenance work that is necessary for optimal, trouble-free operation. Maintenance intervals must be observed.

If increased wear of individual components or functional groups is revealed during regular inspections, the operator must reduce the required maintenance intervals on the basis of the actual signs of wear.

In case of queries regarding the maintenance work and intervals: contact the authorised dealer or manufacturer (service address à Page 2).

Interval	Maintenance work	To be carried out by
Every 6 months	Visual inspection of the outer swing door for damage. Clean the housing and repair paint damage as necessary.	Specialist
	Check the locking bracket function	Specialist
	Check the locking bracket fastening (threaded pins)	Specialist
	Check glass wing fastening (recessed head screw).	Specialist
	Check function of the residual current operated device	Qualified electrician
Every 12 months	Check electrical cables for damage.	Qualified electrician
	Check all electrical connections for tight fit.	Qualified electrician
	Check signs and labels for legibility.	Specialist
	Check foundation attachment.	Specialist
The electrical tests are to be performed in accordance with the regulations applicable at the installation site.		

Table 9: Maintenance schedule

13 Spare parts

! WARNING!	
	<p>WARNING! Risk of injury by incorrect spare parts!</p> <p>Incorrect or defective spare parts can result in damage, malfunctions or total failure and also impair safety.</p> <p>Therefore:</p> <ul style="list-style-type: none"> – Use only the manufacturer's original spare parts.

Procure spare parts from authorised dealers or directly from the manufacturer. Refer to Page 2 for address.

Spare part drawings can be obtained on request.

14 Decommissioning and disposal

NOTICE!	
	<p>NOTICE! Danger for the environment by hazardous materials!</p> <p>Incorrect handling of environmentally hazardous materials, in particular incorrect disposal, can substantially damage the environment.</p> <p>Therefore:</p> <ul style="list-style-type: none"> – Observe the valid environmental directives. – After appropriate disassembly, the parts have to be recycled. – Separate the recyclable resources and send them to recycling. – Dispose lubrication and grease properly. – Take immediate suitable measures if environmentally hazardous materials are inadvertently released into the environment. In case of doubt, inform the responsible local authority about the damage.

Decommissioning and disposal

A barrier module that is no longer usable should not be recycled as a complete unit, but disassembled into individual components and recycled according to material types. Non-recyclable materials have to be disposed of in an environmental-friendly manner.

- The disassembly and disposal of the barrier module may only be carried out by specialised staff.
- Lubricants and greases must be properly stored and must not be allowed to enter the environment in an uncontrolled fashion.
- The barrier module has to be disposed of in accordance with the respective country-specific regulations.

Risk of fire

WARNING!



WARNING!

Risk of injury by fire!

Incorrect disposal of combustible or flammable materials can cause fire and therefore serious injuries or death.

Therefore:

- Dispose combustible or flammable materials correctly and not with normal rubbish.



NOTE!

For expert information regarding disposal of electric equipment contact MAGNETIC or competent electricians.

Conformity declaration

15 Conformity declaration

Der Hersteller/ manufacturer

MAGNETIC Autocontrol GmbH

Grienmatt 20
D-79650 Schopfheim

Telefon +49 (0) 7622 / 695-5
Telefax +49 (0) 7622 / 695-602

Dokumentationsbevollmächtigter /Documentation Engineer

Herr Stefan Wellinger

Telefon +49 (0) 7622 / 695 719

erklärt hiermit für das von ihm gelieferte Produkt/ *this is to certify that the delivered product*

Bezeichnung/ <i>designation</i>	Sperre compact / swing gate compact
Typ/ <i>type</i>	MPS-122*
Serien-Nr./ <i>serial no.</i>	F05392073

die Konformität nach/ *corresponds to the conformity of*

Richtlinie/ directive 2006/42/EG (Maschinen-Richtlinie/ *machine directive*)

Richtlinie/ directive 2006/95/EG (Niederspannungs-Richtlinie/ *low voltage directive*)

Richtlinie/ directive 2004/108/EG (EMV-Richtlinie/ *EMC directive*)

Angewandte harmonisierte Normen (oder Teile daraus)/ *Realized harmonized norms (or parts of them):*

EN ISO 12100-2 (2004-04)

Sicherheit von Maschinen - Grundbegriffe, allgemeine Gestaltungsleitsätze- Teil 2: Technische Leitsätze/ *safety of machinery - basic concepts, general principles for design - part 2: technical principles*

EN 60204-1 (2007-06)

Sicherheit von Maschinen - Elektrische Ausrüstung von Maschinen- Teil 1: Allgemeine Anforderungen/ *Safety of Machinery - Electrical Equipment of Machines- Part 1: Specifications for General Requirements*

EN 61000-6-2 (2006-03)

Elektromagnetische Verträglichkeit (EMV)- Teil 6-2: Fachgrundnormen- Störfestigkeit für Industriebereich/ *Electromagnetic compatibility (EMC) - Part 6-2: Generic standards - Immunity for industrial environments*

EN 61000-6-4 (2007-09)

Elektromagnetische Verträglichkeit (EMV)- Teil 6-4: Fachgrundnormen- Störaussendung für Industriebereich/ *Electromagnetic compatibility (EMC) - Part 6-4: Generic standards - Emission standard for industrial environments*

Diese Erklärung ist keine Zusicherung von Eigenschaften im Sinne des Produkthaftungsgesetzes. Die Sicherheitshinweise der Bedienungsanleitung sind zu beachten./ *This declaration is not a guarantee of characteristics in the sence of product liability law. The safety regulations of the operations manual/maintenance instructions have to observed.*

Schopfheim, den 05/02/2010

Ort und Datum/ *place and date*



Unterschrift/ *signature*

16 Appendix

16.1 Electric circuit diagram

The electric circuit diagram 5527,5114 is supplied as a separate document.

Index

Index

A		L	
Assemble MPS column.....	33	Limitation of liability	9
Assemble swing door.....	25	M	
Assembly		Maintenance.....	60
Disassemble Swing Door	27	Maintenance schedule	63
Swing door on the foundation	26	MBC 111	
Assembly and installation		Funtion description	37
Requirements for assembly	22	Mode: MPS Standard.....	41
C		MPS-Diag programme	44
CAN bus addressing.....	40	O	
Cleaning.....	62	Occupational safety	14, 15
Commissioning	36	Operating conditions	
Conformity declaration.....	11, 66	Technical data	18
Copyright protection.....	9	Operating Instructions.....	7
Customer service.....	11	Operating personnel	
D		Requirements	13
Decommissioning.....	64	P	
Design.....	19	Parameter settings.....	46
Designs	20	Performance data	
Diagnosis display	39	Technical data	18
Digital inputs	37	Personal protective equipment	14
Disposal	64	Pictogram explanation	8
E		Q	
Electric circuit diagram.....	67	Qualified electricians	13
Electrical connection.....	30	R	
Technical data	18	Relay outputs	38
Emergency.....	43	S	
Empty conduits	23	Safety	12
Environmental protection	11	Assembly and installation.....	21
Error code	39	Commissioning.....	35
F		Electrical connection	30
Firmware download	55	Maintenance.....	60
Foundation	23	Scope of delivery	10
Foundation plan	24	Setting end stops	34
Function	20	Spare parts.....	10, 64
Function settings.....	46	Specialised staff.....	13
G		Supply voltage connection terminals	32
General	7	T	
H		Technical data.....	18
Hazard notes.....	15	Termination	40
Homing.....	41		
I			
Instructed people	13		
Intended use	12		

W

Warning notes	8
Warranty	9
Warranty conditions	11
Weight	
Technical data.....	18

MAGNETIC Autocontrol GmbH
Grienmatt 20
79650 Schopfheim
Germany

Tel.: +49 7622 695 5
Fax: +49 7622 695 602
e-mail: info@ac-magnetic.com



Magnetic Autocontrol GmbH

Grienmatt 20
D-79650 Schopfheim
Phone. 07622 695 644
Techn. Support

Job number 5527,5114
Customer Standard
Commission MPS-122C-A111-100
End customer / Place of installation

Type pedestrian gate

Edit date 21.01.2010 by (short name) probst Number of pages 5

A2
/4.3

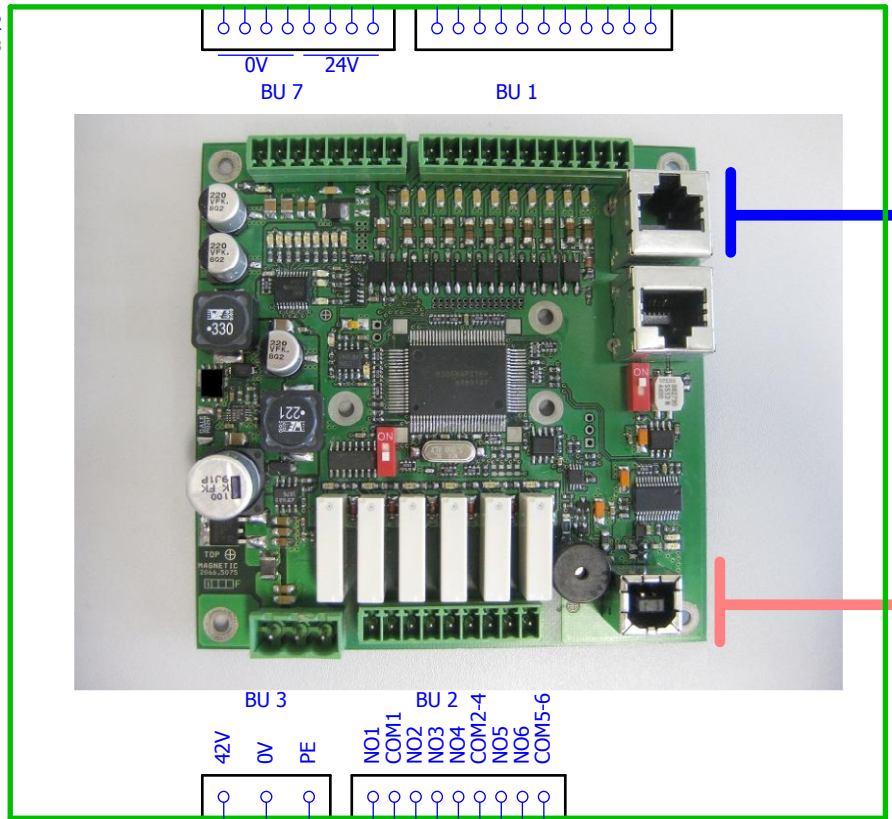

→ MBC_MMC120 / 5.0

USB-cable *
not fixed

*
USB-cable with MPS DIAG
software for
parametrization

2.8 / 42 → 42 / 5.0
2.8 / 0V(42) → 0V(42) / 5.0

2

input configuration

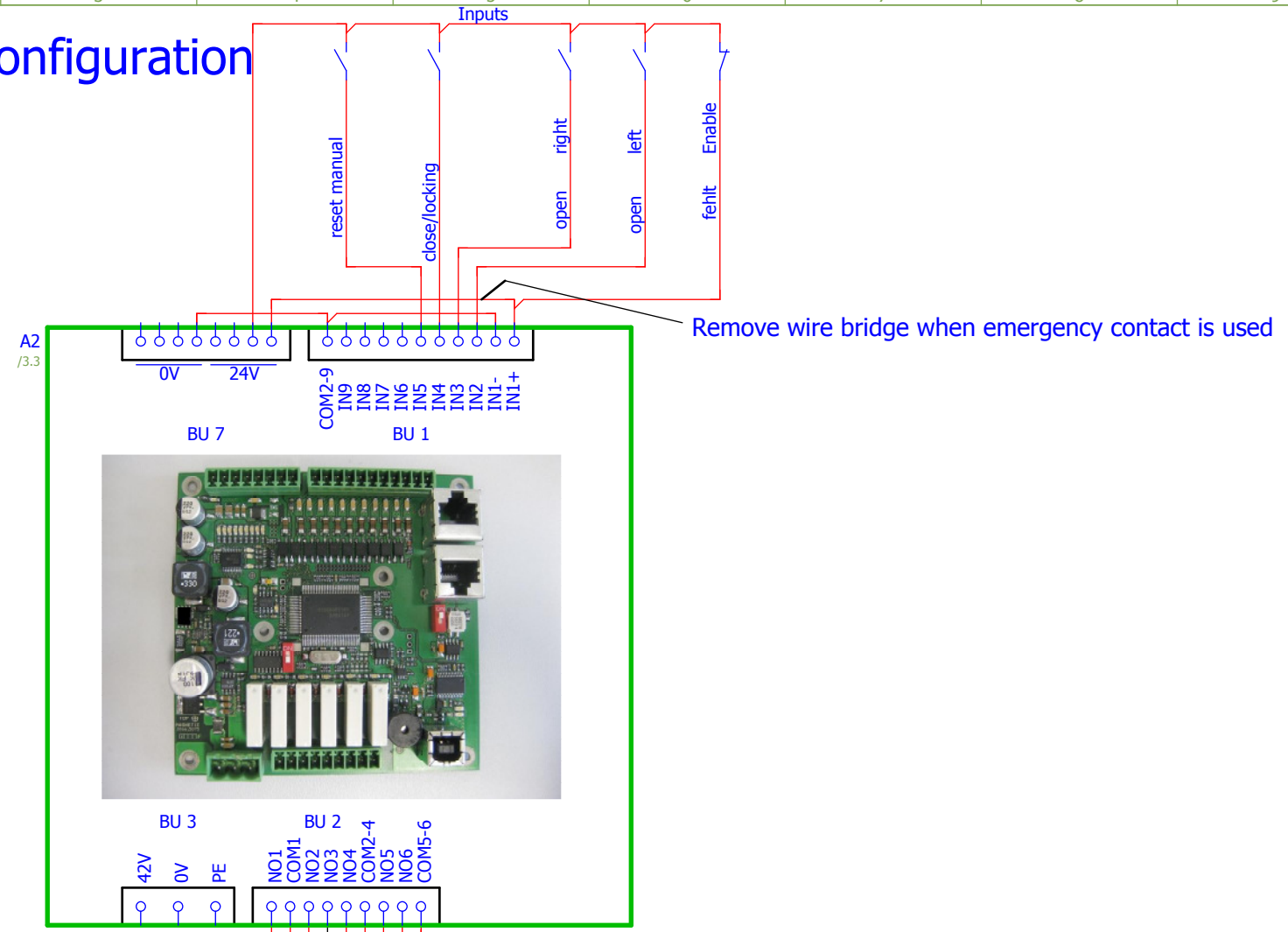

output configuration

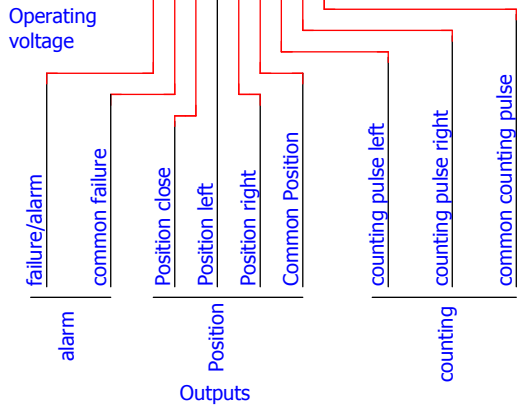

				05.08.2009 probst	Standard MPS-122C-A111-100		in/output configuration MBC-111B		
01	22.12.09	7K09534	gp	00 7K09534					

3.9 / 42
3.9 / 0V(42)

M1 Servomotor+Coupling

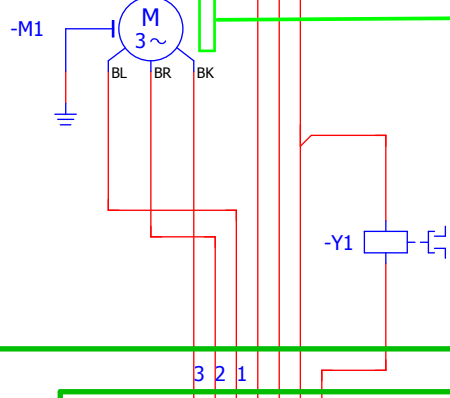

A3

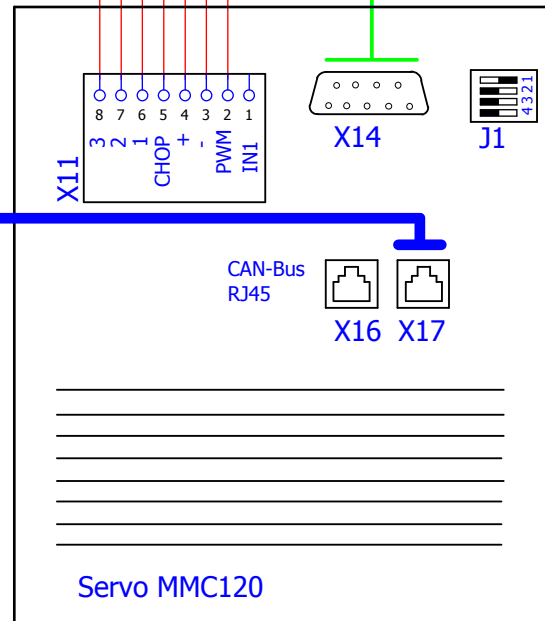

patch cable

3.9 / MBC_MMC120

⚠
4 = off
3 = off
2 = off
1 = on
=ID25

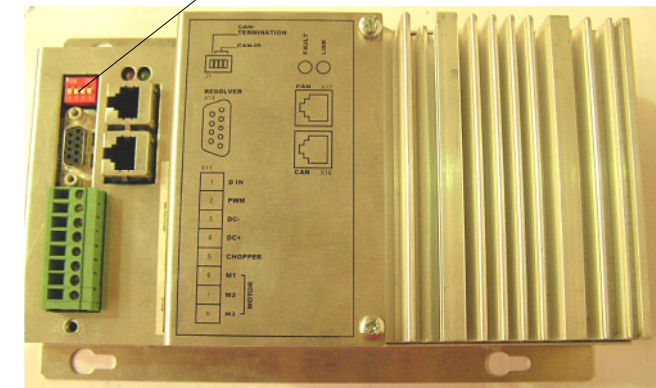

				05.08.2009 probst
01	22.12.09	7K09534	gp	
Version	Date	Modification project	Name	00 7K09534